



# SUPERSTAR II

## User Manual



---

## **SUPERSTAR II User Manual**

**Publication Number:** OM-20000077  
**Revision Level:** 3  
**Revision Date:** 2004/03/11

### **Proprietary Notice**

Information in this document is subject to change without notice and does not represent a commitment on the part of NovAtel Inc. The software described in this document is furnished under a licence agreement or non-disclosure agreement. The software may be used or copied only in accordance with the terms of the agreement. It is against the law to copy the software on any medium except as specifically allowed in the license or non-disclosure agreement.

No part of this manual may be reproduced or transmitted in any form or by any means, electronic or mechanical, including photocopying and recording, for any purpose without the express written permission of a duly authorized representative of NovAtel Inc.

The information contained within this manual is believed to be true and correct at the time of publication.

NovAtel is a registered trademark of NovAtel Inc.

SUPERSTAR, FlexPak-SSII and StarView are trademarks of NovAtel Inc.

All other brand names are trademarks of their respective holders.

© Copyright 2003-2004 NovAtel Inc. All rights reserved.

Unpublished rights reserved under International copyright laws.

# Table of Contents

<b>Software License</b>	<b>7</b>
<b>Customer Service</b>	<b>9</b>
<b>Notices</b>	<b>10</b>
<b>Warranty Policy</b>	<b>12</b>
<b>Foreword</b>	<b>13</b>
<b>1 Introduction</b>	<b>14</b>
1.1 SUPERSTAR II GPS Card .....	14
1.2 FlexPak-SSII .....	15
<b>2 Receiver Specifications</b>	<b>17</b>
2.1 System Architecture .....	17
2.2 Physical Characteristics .....	17
2.2.1 Radio Frequency (RF) Section .....	17
2.2.2 Digital Electronics Section .....	17
2.3 Enclosure and Wiring Harness .....	18
2.4 GPS Antenna .....	18
2.4.1 Optional LNA Power Supply .....	18
2.5 Principal Power Supply .....	18
2.6 Data Communications Equipment .....	18
<b>3 Installation</b>	<b>19</b>
3.1 Electrostatic Discharge .....	20
3.2 Equipment Interconnection .....	20
3.2.1 Serial Connection .....	20
3.2.2 Power Connection .....	21
3.3 Installation Considerations .....	21
3.3.1 Antenna Location .....	21
3.3.2 Base Station Location .....	21
3.3.3 Data Link .....	22
3.3.4 Base Station and Rover Units Separation .....	22
3.4 Connectors and Connector Pins Assignment .....	22
3.4.1 J1 Interface and Power Connector .....	22
3.4.2 Serial Data Interface .....	23
3.4.3 RF Connector (J2) .....	23
3.4.4 Memory Back-Up .....	24
3.5 Protocol Selection and Non Volatile Memory .....	24
3.5.1 Non Volatile Memory .....	26
3.6 Default Configuration .....	26
3.7 Installation Overview .....	27
<b>4 Operation</b>	<b>28</b>
4.1 Communications with the Receiver .....	29
4.1.1 Serial Port Default Settings .....	29
4.2 Getting Started .....	29
4.2.1 Power-Up Information .....	30
4.2.2 Boot Information .....	30
4.2.3 Operational Information .....	30
4.3 Data Requests .....	31
4.4 Configurable Parameters .....	31

---

4.4.1 Mask Angle.....	31
4.4.2 GPS Antenna Position.....	31
4.5 Receiver States .....	31
4.5.1 Non-Operational State.....	31
4.5.2 Operational States.....	31
4.6 Built-In Status Tests.....	33
4.7 DATUM Support .....	34
<b>5 Message Formats</b>	<b>35</b>
5.1 RTCM-Format Messages .....	35
5.1.1 RTCM1 Differential GPS Corrections (Fixed).....	35
5.1.2 RTCM2 Delta Differential GPS Corrections (Fixed) .....	36
5.1.3 RTCM9 Partial Satellite Set Differential Corrections .....	36
5.2 NMEA Format Data Messages .....	37
<b>6 Positioning Modes of Operation</b>	<b>38</b>
6.1 Single-Point or Autonomous .....	38
6.1.1 GPS System Errors .....	38
6.2 Satellite-Based Augmentation System (SBAS) .....	39
6.2.1 SBAS Receiver.....	40
6.2.2 SBAS Messages .....	40
<b>7 Troubleshooting</b>	<b>42</b>

## APPENDICES

---

<b>A Technical Specifications</b>	<b>44</b>
<b>B FlexPak-SSII Specifications</b>	<b>49</b>
<b>C Antenna Specifications</b>	<b>56</b>
<b>D Standards/References</b>	<b>62</b>
<b>E TTFF and Satellite Acquisition</b>	<b>63</b>
<b>F Updating Receiver Firmware</b>	<b>64</b>
<b>G GPS Overview</b>	<b>67</b>
<b>H Glossary of Terms</b>	<b>76</b>
<b>I Acronyms</b>	<b>80</b>

## Tables

---

1	Related Publications .....	13
2	Minimum J1 Connections .....	22
3	Use of Discretes .....	25
4	Discretes IP2 and IP3 functions .....	25
5	Non-Volatile Memory Data .....	26
6	Cable Lengths Vs. Gain .....	42
7	J1 Interfaces and Power Connector Pin Assignment .....	47
8	I/O Signals Voltage Limits .....	48
9	FlexPak Status Indicators .....	50
10	FlexPak COM Ports Pin-Out Descriptions .....	50
11	Coaxial Cable Specifications .....	56
12	Antenna Gain Depending on Cable Length Required .....	57
13	Typical Current Consumption Versus Antenna Gain .....	57
14	Recommended Geodetic Active Antennas .....	58
15	Recommended Active Antennas .....	58
16	Passive Antenna Specifications (Patch Element) .....	59

# Figures

---

1	SUPERSTAR II Receiver .....	14
2	FlexPak-SSII Enclosure .....	15
3	Receiver Block Diagram.....	17
4	Typical System Configuration.....	19
5	Basic Setup .....	27
6	Typical Operational Configuration .....	28
7	The SBAS Concept .....	40
8	SUPERSTAR II Dimensions.....	46
9	FlexPak Power Cable.....	51
10	FlexPak 13-Pin Serial Cable .....	52
11	Differential GPS Setup .....	54
12	GPS Antenna 201-990146-716 (MCX, +12 dB) .....	59
13	GPS Antenna 201-990147-606 (+26 dB) .....	60
14	Coaxial Cable Assembly .....	60
15	GPS Antenna 201-990147-432 (1575 MHz) and 201-990144-807 (Pre-Amplifier).....	61
16	Update Registration Window in DOS .....	64
17	Paste the Registration Key into the DOS Window .....	65
18	Configuration Accepted .....	65
19	Update Utility Activation .....	65
20	End of Programming Session.....	66
21	NAVSTAR Satellite Orbit Arrangement.....	67
22	Illustration of Receiver Height Measurements.....	69
23	Accuracy versus Precision .....	70
24	Example of Differential Positioning.....	71
25	Illustration of GPS Signal Multipath.....	72
26	GPS Signal Multipath vs. Increased Antenna Height .....	74
27	Illustration of Quadrifilar vs. Microstrip Patch Antennas.....	75

# Software License

BY INSTALLING, COPYING, OR OTHERWISE USING THE SOFTWARE PRODUCT, YOU AGREE TO BE BOUND BY THE TERMS OF THIS AGREEMENT. IF YOU DO NOT AGREE TO THE TERMS OF THIS AGREEMENT, DO NOT INSTALL, COPY OR USE THE SOFTWARE PRODUCT.

1. License: NovAtel Inc. ("NovAtel") grants you a non-exclusive, non-transferable license (not a sale) to use one copy of the enclosed NovAtel software on a single computer, and only with the product it was supplied with. You agree not to use the software for any purpose other than the due exercise of the rights and licences hereby agreed to be granted to you.
2. Copyright: NovAtel owns, or has the right to sublicense, all copyright, trade secret, patent and other proprietary rights in the software and the software is protected by national copyright laws, international treaty provisions and all other applicable national laws. You must treat the software like any other copyrighted material except that you may either (a) make one copy of the software solely for backup or archival purposes, the media of said copy shall bear labels showing all trademark and copyright notices that appear on the original copy, or (b) transfer the software to a single hard disk provided you keep the original solely for backup or archival purposes. You may not copy the product manual or written materials accompanying the software. No right is conveyed by this Agreement for the use, directly, indirectly, by implication or otherwise by Licensee of the name of NovAtel, or of any trade names or nomenclature used by NovAtel, or any other words or combinations of words proprietary to NovAtel, in connection with this Agreement, without the prior written consent of NovAtel.
3. Patent Infringement: NovAtel shall not be liable to indemnify the Licensee against any loss sustained by it as the result of any claim made or action brought by any third party for infringement of any letters patent, registered design or like instrument of privilege by reason of the use or application of the software by the Licensee or any other information supplied or to be supplied to the Licensee pursuant to the terms of this Agreement. NovAtel shall not be bound to take legal proceedings against any third party in respect of any infringement of letters patent, registered design or like instrument of privilege which may now or at any future time be owned by it. However, should NovAtel elect to take such legal proceedings, at NovAtel's request, Licensee shall co-operate reasonably with NovAtel in all legal actions concerning this license of the software under this Agreement taken against any third party by NovAtel to protect its rights in the software. NovAtel shall bear all reasonable costs and expenses incurred by Licensee in the course of co-operating with NovAtel in such legal action.
4. Restrictions: You may not: (1) copy (other than as provided for in paragraph 2), distribute, transfer, rent, lease, lend, sell or sublicense all or any portion of the software; (2) modify or prepare derivative works of the software; (3) use the software in connection with computer-based services business or publicly display visual output of the software; (4) transmit the software over a network, by telephone or electronically using any means; or (5) reverse engineer, decompile or disassemble the software. You agree to keep confidential and use your best efforts to prevent and protect the contents of the software from unauthorized disclosure or use.
5. Term and Termination: This Agreement and the rights and licences hereby granted shall continue in force in perpetuity unless terminated by NovAtel or Licensee in accordance herewith. In the event that the Licensee shall at any time during the term of this Agreement: i) be in breach of its obligations hereunder where such breach is irremediable or if capable of remedy is not remedied within 30 days of notice from NovAtel requiring its remedy; or ii) be or become bankrupt or insolvent or make any composition with its creditors or have a receiver or manager appointed of the whole or any part of its undertaking or assets or (otherwise as a solvent company for the purpose of and followed by an amalgamation or reconstruction hereunder its successor shall be bound by its obligations hereunder) commence to be wound up; or iii) be acquired or otherwise come under the direct or indirect control of a person or persons other than those controlling it, then and in any event NovAtel may forthwith by notice in writing terminate this Agreement together with the rights and licences hereby granted by NovAtel. Licensee may terminate this Agreement by providing 30 days prior written notice to NovAtel. Upon termination, for any reasons, the Licensee shall promptly, on NovAtel's request, return to NovAtel or at the election of NovAtel destroy all copies of any documents and extracts comprising or containing the software. The Licensee shall also erase any copies of the software residing on Licensee's computer equipment. Termination shall be without prejudice to the accrued rights of either party, including payments due to NovAtel. This provision shall survive termination of this Agreement howsoever arising.
6. Warranty: For 90 days from the date of shipment, NovAtel warrants that the media (for example, compact

disk) on which the software is contained will be free from defects in materials and workmanship. This warranty does not cover damage caused by improper use or neglect. NovAtel does not warrant the contents of the software or that it will be error free. The software is furnished "AS IS" and without warranty as to the performance or results you may obtain by using the software. The entire risk as to the results and performance of the software is assumed by you.

7. Indemnification: NovAtel shall be under no obligation or liability of any kind (in contract, tort or otherwise and whether directly or indirectly or by way of indemnity contribution or otherwise howsoever) to the Licensee and the Licensee will indemnify and hold NovAtel harmless against all or any loss, damage, actions, costs, claims, demands and other liabilities of any kind whatsoever (direct, consequential, special or otherwise) arising directly or indirectly out of or by reason of the use by the Licensee of the software whether the same shall arise in consequence of any such infringement, deficiency, inaccuracy, error or other defect therein and whether or not involving negligence on the part of any person.
8. For software UPDATES and UPGRADES, and regular customer support, contact the NovAtel GPS Hotline at 1-800-NOVATEL (U.S. or Canada only), or 403-295-4900, or fax 403-295-4901, e-mail to support@novatel.ca, visit our website <http://www.novatel.ca> or write to:

NOVATEL INC.  
CUSTOMER SERVICE DEPT.  
1120 - 68 AVENUE NE,  
CALGARY, ALBERTA, CANADA T2E 8S5

9. Disclaimer of Warranty and Limitation of Liability:
  - a. THE WARRANTIES IN THIS AGREEMENT REPLACE ALL OTHER WARRANTIES, EXPRESS OR IMPLIED, INCLUDING ANY WARRANTIES OF MERCHANTABILITY OR FITNESS FOR A PARTICULAR PURPOSE. NovAtel DISCLAIMS AND EXCLUDES ALL OTHER WARRANTIES. IN NO EVENT WILL NovAtel's LIABILITY OF ANY KIND INCLUDE ANY SPECIAL, INCIDENTAL OR CONSEQUENTIAL DAMAGES, INCLUDING LOST PROFITS, EVEN IF NovAtel HAS KNOWLEDGE OF THE POTENTIAL LOSS OR DAMAGE.
  - a. NovAtel will not be liable for any loss or damage caused by delay in furnishing the software or any other performance under this Agreement.
  - a. NovAtel's entire liability and your exclusive remedies for our liability of any kind (including liability for negligence) for the software covered by this Agreement and all other performance or non-performance by NovAtel under or related to this Agreement are to the remedies specified by this Agreement.

THIS AGREEMENT IS GOVERNED BY THE LAWS OF THE PROVINCE OF ALBERTA, CANADA. EACH OF THE PARTIES HERETO IRREVOCABLY ATTORNS TO THE JURISDICTION OF THE COURTS OF THE PROVINCE OF ALBERTA.



# Customer Service

## Contact Information

If you have any questions or concerns regarding your SUPERSTAR II, please contact NovAtel Customer Service using any one of the following methods:

NovAtel GPS Hotline:	<b>1-800-NOVATEL</b> (U.S. or Canada) 403-295-4900 (International)
Fax:	403-295-4901
E-mail:	<a href="mailto:support@novatel.ca">support@novatel.ca</a>
Website:	<a href="http://www.novatel.com">www.novatel.com</a>
Write:	NovAtel Inc. Customer Service Dept. 1120 - 68 Avenue NE Calgary, Alberta, Canada T2E 8S5

---

☒ Before contacting NovAtel Customer Service regarding software concerns, please do the following:

1. Issue the *Erase NVM* command, *Message ID# 99*, with value 0 to reset all NVM.

(For details on individual commands and logs, refer to the *L1 GPS Firmware Reference Manual*)

2. Log the following data requests to a file on your PC for 30 minutes

<i>Receiver Status, ID# 49</i>	one shot
<i>Ephemeris Data, ID# 22</i>	continuous
<i>Measurement Block, ID# 23</i>	1 Hz
<i>HW/SW Identification, ID# 45</i>	one shot

3. Send the file containing the log to NovAtel Customer Service, using either the NovAtel ftp site at <ftp://ftp.novatel.ca/incoming> or the [support@novatel.ca](mailto:support@novatel.ca) e-mail address.

---

## Firmware Updates

Firmware updates are firmware revisions to an existing model, which improves basic functionality of the GPS receiver. See also *Appendix F, Updating Receiver Firmware on Page 64*.

Firmware upgrades are firmware releases, which increase basic functionality of the receiver from one model to a higher level model type. When available, upgrades may be purchased at a price, which is the difference between the two model types on the current NovAtel GPS Price List plus a nominal service charge.

If you need further information, please contact NovAtel using one of the methods given above.

# Notices

The following notices apply to the SUPERSTAR II card.

The receiver operates within the performance requirements specified herein.

## ***Electrostatic Discharge***

This equipment contains components which are sensitive to damage by electrostatic discharge (ESD).

A label bearing an ESD marking appears on packaging for the card.

When cards have to be replaced or returned for service the following precautions should be observed:

1. Handle the card as little as possible. Do not touch the leads, pin or tracks while handling.
2. Keep spare cards in the ESD protective packing until they are ready for use.
3. Discharge static before handling the cards (removal or replacement) by touching a grounded metallic surface such as a rack or cabinet hardware. Use of wrist strap grounded through a one mega-ohm resistor is preferred when handling cards. (This ground should be the same as the equipment ground).
4. Do not slide static-sensitive cards over any surface.
5. Clothing must not come in contact with components or assemblies. Wear short sleeves or roll-up long sleeves.
6. Package parts properly for storage or transportation. Cards which are removed from the equipment should be placed into ESD protective packing immediately. Do not place any paper, card or other plastic inside the ESD protective packing.
7. When packing these cards for storage or transportation, keep them in the bag. Fold over and seal the mouth of the bag to keep out any static generating packing material (for example foamed polystyrene). Pack around the bag firmly to prevent motion which could generate static.

The following notices apply to the FlexPak-SSII.

## ***FCC Notice***

This equipment has been tested and found to comply with the limits for a Class A digital device, pursuant to Part 15 of the FCC Rules. These limits are designed to provide reasonable protection against harmful interference when the equipment is operated in a commercial environment. This equipment generates, uses, and can radiate radio frequency energy and, if not installed and used in accordance with the instruction manual, may cause harmful interference to radio communications. Operation of this equipment in a residential area is likely to cause harmful interference in which case the user will be required to correct the interference at his own expense.

If this equipment does cause harmful interference to radio or television reception, which can be determined by turning the equipment off and on, the user is encouraged to try to correct the interference by one or more of the following measures:

- Reorient or relocate the receiving antenna.
- Increase the separation between the equipment and receiver.
- Connect the equipment into an outlet on a circuit different from that to which the receiver is connected.
- Consult the dealer or an experienced radio/TV technician for help.



**WARNING:** Changes or modifications to this equipment not expressly approved by NovAtel Inc. could result in violation of Part 15 of the FCC rules.

---

---

## **CE Notice**

The enclosures carry the CE mark.

---

---



**WARNING:** This is a Class B product. In a domestic environment this product may cause radio interference in which case the user may be required to take adequate measures.

---

---

## **EMC Common Regulatory Testing**

- EN55022 Radiated and Conducted Emissions
- CISPR 22 Class B
- EN 50081-1 Generic Emissions Class B
- EN 50082-1 Generic Immunity Class B
- EN 61000-4-2 Electrostatic Discharge Immunity
- EN 61000-4-3 Radiated RF EM Field Immunity Test
- EN 61000-4-4 Electrical Fast Transient/Burst Test
- EN 61000-4-6 Conducted Immunity
- EN 61000-4-8 Magnetic Field Immunity

# Warranty Policy

NovAtel Inc. warrants that its Global Positioning System (GPS) products are free from defects in materials and workmanship, subject to the conditions set forth below, for the following periods of time:

SUPERSTAR II GPSCard Receiver	One (1) Year
FlexPak-SSII	One (1) Year
GPSAntenna™ Series	One (1) Year
Cables and Accessories	Ninety (90) Days
Software Support	One (1) Year

Date of sale shall mean the date of the invoice to the original customer for the product. NovAtel's responsibility respecting this warranty is solely to product replacement or product repair at an authorized NovAtel location only.

Determination of replacement or repair will be made by NovAtel personnel or by technical personnel expressly authorized by NovAtel for this purpose.

**THE FOREGOING WARRANTIES DO NOT EXTEND TO (I) NONCONFORMITIES, DEFECTS OR ERRORS IN THE PRODUCTS DUE TO ACCIDENT, ABUSE, MISUSE OR NEGLIGENT USE OF THE PRODUCTS OR USE IN OTHER THAN A NORMAL AND CUSTOMARY MANNER, ENVIRONMENTAL CONDITIONS NOT CONFORMING TO NOVATEL'S SPECIFICATIONS, OR FAILURE TO FOLLOW PRESCRIBED INSTALLATION, OPERATING AND MAINTENANCE PROCEDURES, (II) DEFECTS, ERRORS OR NONCONFORMITIES IN THE PRODUCTS DUE TO MODIFICATIONS, ALTERATIONS, ADDITIONS OR CHANGES NOT MADE IN ACCORDANCE WITH NOVATEL'S SPECIFICATIONS OR AUTHORIZED BY NOVATEL, (III) NORMAL WEAR AND TEAR, (IV) DAMAGE CAUSED BY FORCE OF NATURE OR ACT OF ANY THIRD PERSON, (V) SHIPPING DAMAGE; OR (VI) SERVICE OR REPAIR OF PRODUCT BY THE DEALER WITHOUT PRIOR WRITTEN CONSENT FROM NOVATEL. IN ADDITION, THE FOREGOING WARRANTIES SHALL NOT APPLY TO PRODUCTS DESIGNATED BY NOVATEL AS BETA SITE TEST SAMPLES, EXPERIMENTAL, DEVELOPMENTAL, PREPRODUCTION, SAMPLE, INCOMPLETE OR OUT OF SPECIFICATION PRODUCTS OR TO RETURNED PRODUCTS IF THE ORIGINAL IDENTIFICATION MARKS HAVE BEEN REMOVED OR ALTERED. THE WARRANTIES AND REMEDIES ARE EXCLUSIVE AND ALL OTHER WARRANTIES, EXPRESS OR IMPLIED, WRITTEN OR ORAL, INCLUDING THE IMPLIED WARRANTIES OF MERCHANTABILITY OR FITNESS FOR ANY PARTICULAR PURPOSE ARE EXCLUDED. NOVATEL SHALL NOT BE LIABLE FOR ANY LOSS, DAMAGE, EXPENSE, OR INJURY ARISING DIRECTLY OR INDIRECTLY OUT OF THE PURCHASE, INSTALLATION, OPERATION, USE OR LICENSING OF PRODUCTS OR SERVICES. IN NO EVENT SHALL NOVATEL BE LIABLE FOR SPECIAL, INDIRECT, INCIDENTAL OR CONSEQUENTIAL DAMAGES OF ANY KIND OR NATURE DUE TO ANY CAUSE.**

There are no user serviceable parts in the GPS receiver and no maintenance is required. When the status code indicates that a unit is faulty, replace with another unit and return the faulty unit to NovAtel Inc.

Before shipping any material to NovAtel or Dealer, please obtain a Return Material Authorization (RMA) number from the point of purchase. You may also visit our website at <http://www.novatel.com> and select *Support / Repair Request* from the side menu.

Once you have obtained an RMA number, you will be advised of proper shipping procedures to return any defective product. When returning any product to NovAtel, please return the defective product in the original packaging to avoid ESD and shipping damage.

# Foreword

## Congratulations!

Thank you for purchasing a SUPERSTAR II receiver. Whether you have purchased a stand alone GPS card, a packaged receiver or a development kit, this user manual defines the design, operational, physical, interface, functional and performance requirements for the receiver.

## Scope

This document provides information on the SUPERSTAR II GPS OEM board and its optional FlexPak-SSII enclosure. The following sections describe functionality, and mechanical and electrical characteristics of the SUPERSTAR II board. The software messages are described in the companion *L1 GPS Firmware Reference Manual*, NovAtel part number *OM-20000086*. There are also additional appendices with reference materials for you.

## Related Publications

The related publications are listed in *Table 1*.

PUBLICATION NAME	PUBLICATION NAME
[1] ICD-GPS-200 Rev. B	NAVSTAR GPS Space Segment/Navigation Interface <sup>a</sup>
[2] RTCM-104 version 2.1 January 1994	Recommended Standards for Differential NAVSTAR GPS Radio Technical Commission for Maritime Services <sup>a</sup>
[3] SAE J1211	SAE Recommended Environmental Practices for Electronic Equipment Design <sup>a</sup>
[4] NMEA-0183 Rev 2.20	National Marine Electronics Association Standard for Interfacing <sup>a</sup>
[5] STARVIEW User Manual	NovAtel Part Number OM-20000081 <sup>b</sup>
[6] L1 GPS Firmware Reference Manual (for SUPERSTAR II-based products)	NovAtel Part Number OM-20000086 <sup>b</sup>

- a. See *Appendix D, Standards/References on Page 62* for contact information.
- b. For the latest versions of these manuals, visit our website at <http://www.novatel.com/Products/productmanuals.html>.

**Table 1: Related Publications**

The SUPERSTAR II, see *Figure 1* below, is a quality GPS receiver for embedded applications. The SUPERSTAR II has robust signal tracking capability even under difficult signal conditions.

The SUPERSTAR II is a complete GPS OEM sensor that provides 3D navigation on a single compact board with full differential capability. The SUPERSTAR II is a 12-channel GPS receiver that tracks all in-view satellites. It is fully autonomous such that once power is applied, the SUPERSTAR II automatically searches, acquires and tracks GPS satellites. SUPERSTAR II receivers also have Satellite Based Augmentation System (SBAS) capability, for example WAAS and EGNOS. When a sufficient number of satellites are tracked with valid measurements, the SUPERSTAR II produces a 3-D position and velocity output with an associated figure of merit (FOM).



**Figure 1: SUPERSTAR II Receiver**

This L1 GPS receiver is available in 2 formats:

- as an OEM board
- within the FlexPak-SSII enclosure

## 1.1 SUPERSTAR II GPS Card

The main features of the SUPERSTAR II are:

- Decodes differential corrections encoded in the RTCM message format
- Twelve channel correlator for all-in-view satellite tracking
- Single chip RF front end
- SBAS support
- Active, and passive, antenna support
- Single 5V power input
- Complete L1 GPS receiver and navigator on a single compact board
- Two general purpose input lines
- One general purpose input/output (GPIO) line

- Operating temperature range of -30°C to +75°C
- 1PPS output aligned on GPS Time  $\pm 200$  ns
- 1Hz measurement output aligned on GPS Time
- Support for 62 predefined datums
- Field-upgradeable firmware (stored in Flash memory) through the TTL serial port
- Code and Carrier Phase tracking of L1 GPS frequency for increased accuracy
- Retention of satellite almanac and ephemeris data in non-volatile memory for rapid time-to-first-fix (TTFF) after power interruption
- Very fast signal re-acquisition when signal masking (obstruction or vehicle attitude) occurs
- Allows for warm start
- 1 Hz Position, Velocity and Time (PVT) output

Available Model Features<sup>1</sup>:

- 1 or 10 Hz carrier phase measurements (*Message ID# 23, Measurement Block Data* only works with these models)
- Precise timing
- 5 Hz PVT output
- RTCM DGPS Base

## 1.2 FlexPak-SSII

The FlexPak-SSII, see *Figure 2*, is a hardware interface between your equipment and the SUPERSTAR II GPS card. The Development Kit is an equipment set permitting easy evaluation of the receiver and includes the SUPERSTAR II GPS card in a FlexPak-SSII enclosure. It provides single-frequency positioning with two COM ports. A full description of this Development Kit and technical specifications of the FlexPak-SSII are provided in *Appendix B, FlexPak-SSII Specifications*, starting on *Page 49*.



**Figure 2: FlexPak-SSII Enclosure**

The FlexPak-SSII offers the following features:

- A shock and dust resistant enclosure
- Waterproof to IEC 60529 standards IPX4 and IPX7

1. Refer to *Appendix A* of the *L1 GPS Firmware Reference Manual* for models and their capabilities.

- Low power consumption
- Two RS-232 serial ports
- PPS output
- Configurable mark inputs
- Indicators for position, communication status and power

If you purchased a SUPERSTAR II Development Kit, the following is also provided with your FlexPak-SSII:

- 1 Deutsch to DB-9 serial cable
- 1 Deutsch to automobile power connector cable
- 1 AC/DC adaptor
- 1 +12 dB active GPS antenna with magnetic mount and integrated RF cable (6 m)
- 1 CD containing:
  - An installation program for NovAtel's GPS L1 graphical user interface software, *StarView*
  - Product documentation, including user manuals



## 2.1 System Architecture

Figure 3 below depicts the block diagram of the receiver assembly.

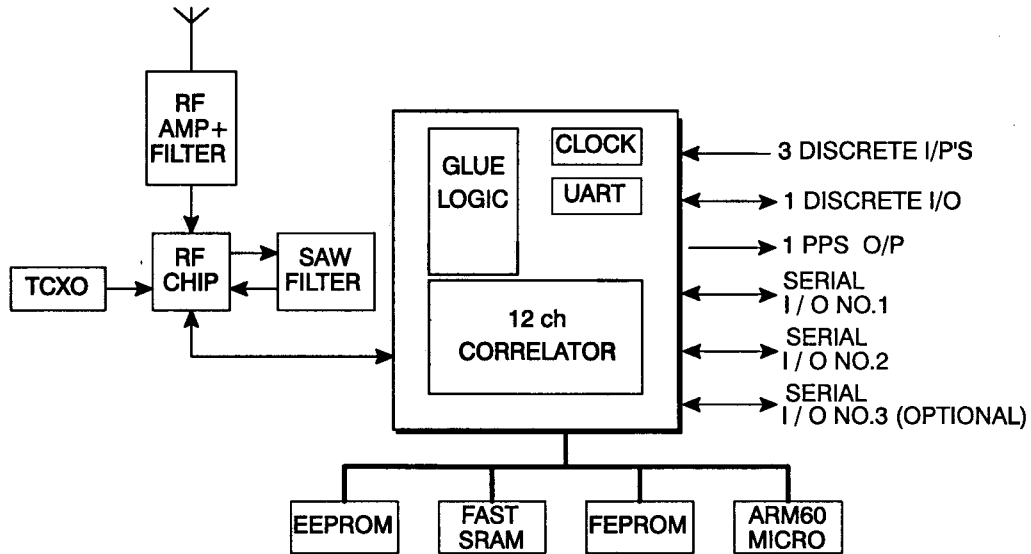

Figure 3: Receiver Block Diagram

## 2.2 Physical Characteristics

This section applies to the OEM board version of the receiver.

For details on the physical characteristics of the FlexPak-SSII version of the receiver, please see *Appendix B, FlexPak-SSII Specifications*, starting on Page 49.

The receiver assembly consists of one printed circuit board (PCB) containing a shielded RF section, digital and I/O sections located on both sides of the PCB, and a surface mount connector. The receiver does not require heat-sinking to a metal case.

Mechanical packaging of the receiver is designed to allow for mounting within various different configurations of OEM units.

### 2.2.1 Radio Frequency (RF) Section

The receiver obtains a partially filtered and amplified GPS signal from the antenna through the coaxial cable. The RF section performs the translation from the incoming RF signal to an IF signal usable by the digital section. It also supplies power to the active antenna's LNA through the coaxial cable while maintaining isolation between the DC and RF paths. The RF section can reject a high level of potential interference (e.g., MSAT, Inmarsat, cellular phone, and TV sub-harmonic signals).

### 2.2.2 Digital Electronics Section

The digital section of the receiver, receives a down-converted, amplified GPS signal which it digitizes and processes to obtain a GPS solution (position, velocity and time). The digital section consists of an analog-to-

digital converter, a 16-bit system processor, memory, control and configuration logic, signal processing circuitry, serial peripheral devices, and supporting circuitry.

The digital section performs the translations and calculations necessary to convert the IF analog signals into usable position and status information. It also handles all I/O functions, including the auxiliary strobe signals, which are described in detail in *Section 3.4, Connectors and Connector Pins Assignment* starting on *Page 22*. For input and output levels please see *Appendix A, Technical Specifications*, starting on *Page 44*.

## 2.3 Enclosure and Wiring Harness

An enclosure is necessary to protect the GPSCard from environmental exposure and RF interference. If a FlexPak-SSII is not being used as the enclosure, a wiring harness is also required to provide an interface to the SUPERSTAR II's antenna and power inputs as well as data and status signals.

## 2.4 GPS Antenna

The purpose of the GPS antenna is to convert the electromagnetic waves transmitted by the GPS satellites into RF signals. An active or passive GPS antenna may be used in the operation of the receiver. NovAtel's active antennas are recommended.

### 2.4.1 Optional LNA Power Supply

Power for the antenna LNA is normally supplied by RF cable to J2, see also *Section 3.4.3, RF Connector (J2)* starting on *Page 23*. However, if a different type of antenna is required that is incompatible with this supply, connect an external power source to the receiver.

External LNA power is not possible with a FlexPak-SSII receiver.

## 2.5 Principal Power Supply

A single external power supply capable of delivering 5 V is necessary to operate the receiver. See *Appendix A, Technical Specifications*, starting on *Page 44* for details.



**CAUTION:** If the voltage supplied is below the minimum specification, the receiver will suspend operation. If the voltage supplied is above the maximum specification, the receiver may be permanently damaged, voiding your warranty.

---

---

## 2.6 Data Communications Equipment

A PC or other data communications equipment is necessary to communicate with the receiver and, if desired, to store data generated by the receiver.

This section covers the installation of the receiver.

NovAtel's *StarView* graphical user interface software running on a PC allows you to control the receiver and to display its outputs. See *Section B.3, StarView Software Installation* starting on *Page 55* for its installation instructions. Details on the *StarView* program are provided in Reference [5] on *Page 13*.

The SUPERSTAR II is an OEM product designed for flexibility of integration and configuration. You are free to select an appropriate data and signal interface, power supply system and mounting structure. This allows you to custom-design your own GPS-based positioning system around the SUPERSTAR II.

A typical system configuration is shown in *Figure 4*:

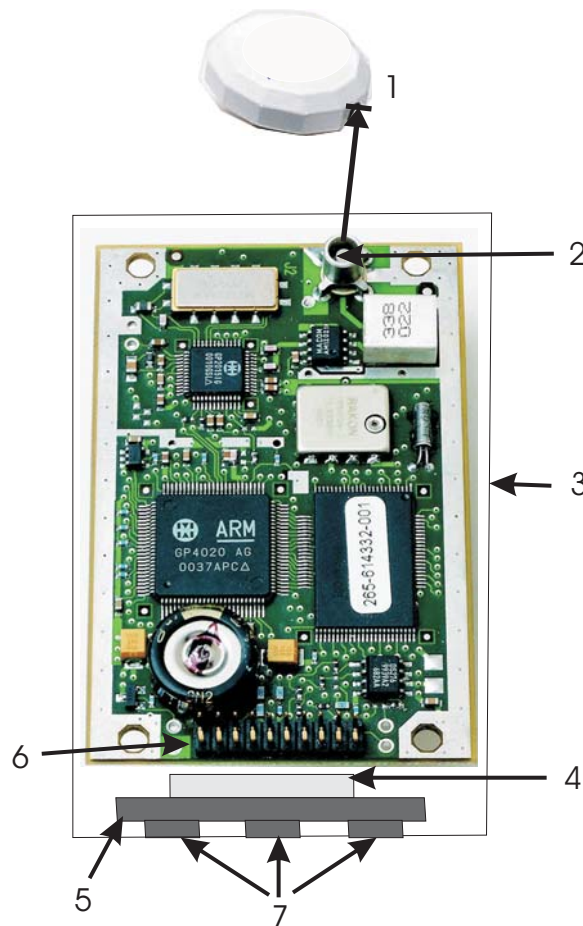

**Figure 4: Typical System Configuration**

Reference	Description
1	J2 to user-supplied GPS antenna
2	J2
3	User-supplied enclosure
4	User-supplied power, data and signal connector to J1
5	User-supplied interface
6	J1
7	COM1, COM2 and power connectors

In order for the SUPERSTAR II to perform optimally, the following additional equipment is required:

- NovAtel GPS antenna
- NovAtel coaxial cable
- Regulated power supply providing +5 VDC
- A wiring harness to provide power (connected to J1) as an interface for power, communications and signals
- Data communication equipment capable of TTL serial communications

See *Appendix B, FlexPak-SSII Specifications*, starting on *Page 49* for a description of the type of enclosure equipment required for the receiver to operate.

## 3.1 Electrostatic Discharge

Electrostatic discharge (ESD) is a leading cause of failure of electronic equipment components and printed circuit boards containing ESD-sensitive devices and components. It is imperative that ESD precautions be followed when handling or installing the SUPERSTAR II printed circuit board. See also the electrostatic discharge notice on *Page 10* of this manual.

Leave the SUPERSTAR II in its anti-static packaging when not connected in its normal operating environment. When removing the SUPERSTAR II from the ESD-protective plastic, follow accepted standard anti-static practices. Failure to do so may cause damage to the SUPERSTAR II.

When you remove the SUPERSTAR II from the original packing box, it is recommended that you save the box and ESD protective plastic for future storage or shipment purposes.

---

### REMEMBER!

- Always wear a properly grounded anti-static wrist strap when handling the SUPERSTAR II.
  - Always hold the SUPERSTAR II by its corners or edges, and avoid direct contact with any of the components.
  - Do not let the SUPERSTAR II come in contact with clothing at any time because the grounding strap cannot dissipate static charges from fabrics.
  - Failure to follow accepted ESD handling practices could cause damage to the SUPERSTAR II.
  - Warranty may be voided if equipment is damaged by ESD.
- 

## 3.2 Equipment Interconnection

As mentioned in *Chapter 1, Introduction*, starting on *Page 14*, the receiver can be provided either as an OEM board, or within a FlexPak-SSII enclosure. The interconnection of the OEM board format is guided by its physical and electrical specifications as detailed in *Section 3.4, Connectors and Connector Pins Assignment* starting on *Page 22*. A complete description of the FlexPak-SSII is provided in *Appendix B, FlexPak-SSII Specifications*, starting on *Page 49*.

### 3.2.1 Serial Connection

The receiver includes two serial communication ports. COM1 and COM2 are detailed in *Section 3.4.2, Serial Data Interface* starting on *Page 23*. Serial communication with the receiver must be performed on COM1. The maximum data transfer rate is 19200 bps. The other serial port, COM2, is used for a differential link, and its minimal data transfer rate is 9600 bps. Communication with COM1 and COM2 is through two Deutsch connectors on the FlexPak-SSII.

Please refer to the *L1 GPS Firmware Reference Manual* for a discussion on the I/O protocol.

### 3.2.2 Power Connection

The input range for a SUPERSTAR II card is either 3.3 VDC or 5 VDC depending on your model. The input range required for the FlexPak-SSII is +6 to +18 VDC.

## 3.3 Installation Considerations

The FlexPak receiver is waterproof. The SUPERSTAR II bare card must be mounted in a dry location. Locate your receiver where it is convenient for cables to run to the power source, display device, and antenna. Form drip loops in the cables to prevent moisture from running down the cables and into the receiver.

Mount the receiver several feet away from radio transmission equipment.

### 3.3.1 Antenna Location

Many GPS reception problems can be reduced, to some degree, by careful antenna site selection. Of primary importance is to place the antenna so that unobstructed line-of-sight reception is possible from horizon to horizon and at all bearings and elevation angles from the antenna. This is, of course, the ideal situation, which may not be possible under actual operating conditions.

1. Try to place the antenna as far as possible from obvious reflective objects, especially reflective objects that are above the antenna's radiation pattern horizon. Close-in reflections cause strong multipath signals. For a detailed discussion on multipath and site selection, see *Section G.4, Multipath* starting on *Page 71*.
2. Care should also be taken to avoid coiling the antenna cable around the mounting base and pinching the antenna cable in window or door jambs.

By default, the SUPERSTAR II uses satellites above 4.5 degrees elevation. The mask angle can be set to use a different cut-off, as low as zero degrees (all in view), using *Message ID# 81, Set Mask Angle* (refer to the *L1 GPS Firmware Reference Manual* for more message details).

### 3.3.2 Base Station Location

---

☒ Your receiver must be a BASE model to act as a base station. A list of models is in *Appendix A* of the *L1 GPS Firmware Reference Manual* and in our Price List available from the Sales side menu of our website at [www.novatel.com](http://www.novatel.com).

---

1. The base station must be located on a site that is above all obscuring elements on the surrounding terrain in order to have all satellites above the horizon visible at the base station's antenna. The intent is to have all satellites that are visible at the roving unit's antenna to be visible at the base station as well.
2. Multipath interference must be minimized as much as possible. Multipath is defined as the interaction of the GPS satellite signal and its reflections. This causes errors mainly on the GPS code, and less so on the GPS carrier. Even though the receiver uses carrier phase measurements, it can revert to code differential GPS operation if carrier phase differential GPS cannot be performed. Hence, the base station's antenna must be far from any reflecting elements.
3. The position of the base station's antenna must be surveyed using appropriate surveying equipment. This position must then be programmed in the base station using *Message ID# 80, Set User's Position/Operating Mode* (refer to the *L1 GPS Firmware Reference Manual*). Any error in the base station's position will be reflected in the roving unit's computed position.

### 3.3.3 Data Link

The data link for differential operation must operate at a minimal rate of 9600 bps.

### 3.3.4 Base Station and Rover Units Separation

The operational range of carrier-phase differential measurements is limited to about 20 km, after which significant accuracy degradation can occur. If your application requires greater separations, your own base station network must be established.

## 3.4 Connectors and Connector Pins Assignment

The receiver has two standard connectors.

- J1 is a 20-pin connector for general input/output interfaces and power input
- J2 is a MCX type RF connector.

The minimum number of connections on J1 required for the system to operate is shown in *Table 2*.

**Table 2: Minimum J1 Connections**

Signal Name	J1 Pin #	Description
VCC	2	Primary power (3.3V or 5.0V -0.5 V/+0.25 V)
GND	10, 13, 16 & 18	Ground
TX_No_1	11	Serial port Tx #1
RX_No_1	12	Serial port Rx #1

If DGPS corrections are required for the application, the SUPERSTAR II can receive them on COM2:

Signal Name	J1 Pin #	Description
RX_No_2	15	Serial port Rx #2

If an active antenna is used:

Signal Name	J1 Pin #	Description
PREAMP	1	Power for active antenna (40 mA max)



**CAUTION:** You should use a current-limiting power source. The maximum current is 40 mA.

See *Appendix A, Technical Specifications*, starting on *Page 44* for more details.

### 3.4.1 J1 Interface and Power Connector

The SUPERSTAR II connector is a 2mm straight 2x10 pin header:

Suggested supplier:  
On-Board connector:

Samtec  
TMM-110-03-T-D.

Interface between SUPERSTAR II and customer application:

Suggested 2 inch ribbon cable:	TCS-D-10-D-2.00-01-N
or	
Suggested 12 inch ribbon cable with only one connector installed:	TCS-D-10-S-12.0-01-N
Suggested mating connector:	TCS-D-10-01-N
or	
PCB mounted connector:	SQT-110-01-L-D <sup>1</sup>

Connector specifications can be obtained from Samtec or other equivalent manufacturer.

### 3.4.2 Serial Data Interface

The receiver includes two COM ports (COM1 and COM2). Both COM ports operate independently with data transfer rates adjustable from 300 to 19200 bps.

COM1 supports data input (for receiver configuration and control) and output (for example, navigation results and receiver status). COM2 only supports data output if your SUPERSTAR II is a BASE model. This model also supports data input (roving unit mode) or output (optional base station mode) for differential correction data adhering to Reference [2] on Page 13.

---

☒ Your receiver must be a BASE model to act as a base station. A list of models is in *Appendix A* of the *L1 GPS Firmware Reference Manual* and in our Price List available from the Sales side menu of our website at [www.novatel.com](http://www.novatel.com).

---

COM1 and COM2 support communication using the binary protocol. Through specific binary messages, the ports are re-configurable to communicate with NovAtel’s PC-based user-interface *StarView* software (for extensive monitoring of SV tracking, measurements and navigation status).

The default data transfer rate is 9600 bps but can be reconfigured (refer to *Message ID# 110, Configure COM1 Port Mode* in the *L1 GPS Firmware Reference Manual*). The new configuration is stored in NVM. If no default message list has been stored in NVM, the receiver will output *Message ID# 20, Navigation Data* (refer to the *L1 GPS Firmware Reference Manual*) at a rate of once per second after each power up.

COM1 can be used for S/W reprogramming (please see *Appendix F, Updating Receiver Firmware*, starting on Page 64).

See also *Section A.2.3* on Page 48 for the electrical characteristics and the *Input/Output Message* rows on Page 45 for COM port details.

---

☒ The default data transfer rate is 9600 bps unless your receiver model has Carrier Phase Output (CP) capability in which case it may be 19200. A list of models is in *Appendix A* of the *L1 GPS Firmware Reference Manual* and in our Price List available from the Sales side menu of our website at [www.novatel.com](http://www.novatel.com).

---

### 3.4.3 RF Connector (J2)

The standard RF connector is a straight MCX jack connector.

Suggested supplier:	Johnson Comp
On-Board connector:	133-3701-211

---

1. 0.340" long standoffs will be required

Interface between SUPERSTAR II and customer application:

Suggested Supplier: Omni Spectra  
Supplier part number: 5831-5001-10

or

Suggested Supplier: Suhner  
Supplier part number: 11MCX-50-2-10C

or

Suggested Supplier: Radiall  
Supplier part number: R113082.

The center conductor provides power for an active antenna (PREAMP signal from J1-1).

### 3.4.3.1 Preamplifier Power Pass-Through (Antenna Supply)

The PREAMP signal is available on the I/O connector for the host to provide power to the antenna preamplifier through the center conductor of the RF cable J2. The maximum operating voltage for an active antenna supply (PREAMP) is 12 Volts.



**CAUTION:** You should use a current-limiting power source. The maximum current on J2 is 40 mA.

---

---

### 3.4.3.2 RF Input

The receiver will receive the GPS signal from the antenna amplifier on the J2 RF input connector. The RF input port impedance is 50 Ohms nominal.

## 3.4.4 Memory Back-Up

The SUPERSTAR II has a supercap device allowing a warm start, where the receiver has an approximate position, an approximate time and a valid almanac, without the need of an external power supply during a power-off state. VBATT is an external back-up source for the time keeping circuit.

A warm start is available for 1 week typically (25°C) and 3 days over a more extreme temperature range (-30 to +75°C). Therefore, VBATT can be used to extend the time retention period.

- 
- An external series diode will be required between J1 and the external power source to prevent the supercap from discharging into your circuitry.
- 

## 3.5 Protocol Selection and Non Volatile Memory

Discrete IOs are available with a SUPERSTAR II card. A summary is shown in *Table 3* on *Page 25*.



**Table 3: Use of Discretes**

Discrete Name	FlexPak Equivalent Name	Use	Direction
GPIO2	IO1	Navigator	IN/OUT
GPIO3	IO2	SP	IN/OUT
GPIO5	IP1	GPS Data	IN/OUT
GPIO6	IP2	NVM Control	IN/OUT
GPIO7	IP3	Protocol Select	IN/OUT

If you use NMEA, the SUPERSTAR II offers you the option of setting the I/O operating mode to NMEA through discrete input levels. Disc\_IP2 and Disc\_IP3 have the following functions:

**Table 4: Discretes IP2 and IP3 functions**

Disc_IP3 (Protocol Select)	Disc_IP2 (NVM Control)	Result
OPEN - HI	OPEN - HI	Configuration stored in NVM or Default ROM Configuration if no valid NVM elements
OPEN - HI	GND	Protocol on Port #1: Binary Baud Rate on Port #1: 9600 Other elements: Default ROM Configuration
GND	OPEN - HI	Protocol on Port #1: NMEA Baud Rate on Port #1: 4800 Other elements: Default ROM Configuration if no valid NVM elements
GND	GND	Protocol on Port #1: NMEA Baud Rate on Port #1: 4800 Other elements: Default ROM Configuration

Discrete inputs are also shown in byte 26 of *Message ID# 49, Receiver Status Data*, refer to the *L1 GPS Reference Manual*.

### 3.5.1 Non Volatile Memory

The receiver stores different types of information used to accelerate the TTFF and to configure the I/O in NVM. See *Table 5* below for a partial list of the data stored in NVM.

**Table 5: Non-Volatile Memory Data**

Parameter	Notes
ALMANAC	The most recent almanac
LAST POSITION	Position in NVM is updated at different rates depending on the application. The last known position is always kept in battery back-up SRAM.
DGPS CONFIGURATION	Differential GPS configuration
TTL CONFIGURATION	Contains the following configuration information: 1. Mode of operation 2. Baud Rate: 300 to 19200 3. Default Binary message list 4. Time Alignment Mode State 5. Mask Angle 6. Datum

### 3.6 Default Configuration

Below is the SUPERSTAR II's default configuration with no valid NVM elements:

Protocol on port #1:	Binary
Baud Rate on port #1:	9600
Protocol on port #2:	RTCM-104
Baud Rate on port #2:	9600
DGPS Correction Timeout:	45 seconds
Default Message List:	
Binary:	Navigation Status User Coordinates (Message ID# 20) @ 1Hz
NMEA:	GGA @ 1Hz
Time Align Mode:	ON

- 
- ☒ 1. The data contained in NVM is always used if the DISC\_IP2 is left unconnected or tied to HI logic.
  - 2. The default data transfer rate is 9600 bps unless your receiver model has Carrier Phase Output (CP) capability in which case it may be 19200. A list of models is in *Appendix A* of the *L1 GPS Firmware Reference Manual* and in our Price List available from the Sales side menu of our website at [www.novatel.com](http://www.novatel.com).
  - 3. If DISC\_IP2 is tied to LO logic, the default ROM configuration will be used and the following parameters will not be read from NVM:
    - Position
    - Almanac
    - Time
    - UTC Correction and IONO Parameters
    - TCXO Parameters
-

### 3.7 Installation Overview

Once you have selected the appropriate equipment, complete the following steps to set up and begin using your NovAtel SUPERSTAR II receiver.

1. If your receiver has been provided as a GPS card without an enclosure, install the card in an enclosure to reduce environmental exposure, RF interference and vibration effects.
2. Pre-wire your I/O harness 20-pin connector for power and communications and connect them to the J1 connector on the SUPERSTAR II. See also *Section 3.4, Connectors and Connector Pins Assignment* starting on *Page 22*.
3. Mount the GPS antenna to a secure, stable structure, as described in *Section 3.3.1 on Page 21*.
4. Connect the GPS antenna to the receiver using an antenna RF cable, using the information given in *Section 3.4.3.1, Preamplifier Power Pass-Through (Antenna Supply)*, and *Section 3.4.3.2, RF Input* starting on *Page 24*.
5. Apply power to the receiver, as described in *Section 3.2.2, Power Connection* starting on *Page 21*.
6. Connect the receiver to a PC or other data communications equipment by following the information given in *Section 3.2.1, Serial Connection* starting on *Page 20* and *3.4.2, Serial Data Interface* on *Page 23*.

Figure 5 shows a typical setup for an enclosed receiver.

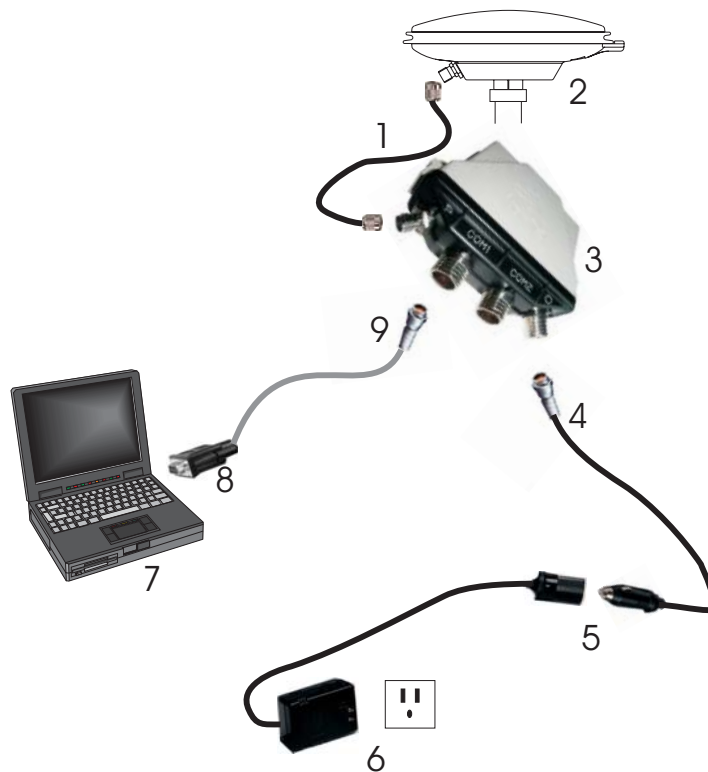
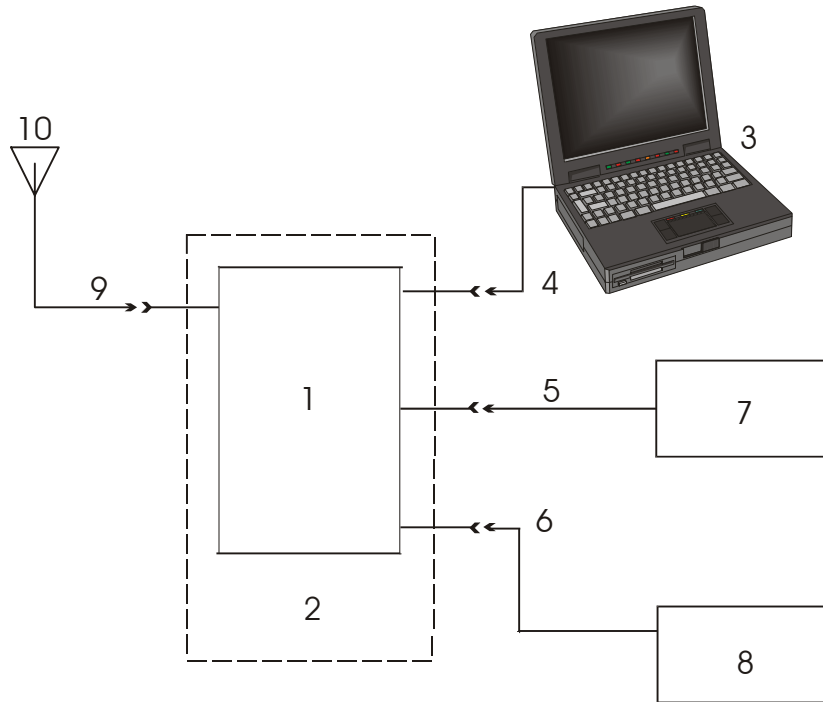

Figure 5: Basic Setup

Reference	Description	Reference	Description
1	Coaxial cable from antenna to FlexPak RF connector (⚡)	5	12 V DC Adaptor
2	Antenna	6	120 V AC power supply
3	FlexPak	7	User-supplied PC
4	To FlexPak power connector (⏻)	8	DB-9 connector to PC
		9	To FlexPak COM port (COM1)

Before operating the receiver for the first time, ensure that you have followed the installation instructions in *Chapter 3, Installation starting on Page 19*. The following instructions are based on a configuration such as that shown in *Figure 6*. It is assumed that a personal computer is used during the initial operation and testing for greater ease and versatility.



**Figure 6: Typical Operational Configuration**

Reference	Description
1	L1 GPS card
2	OEM housing
3	Command source or base station
4	COM1
5	COM2
6	Power
7	Radio or rover station
8	External power source(s)
9	GPS signal
10	GPS antenna

---

☒ Your receiver must be a BASE model to act as a base station. A list of models is in *Appendix A* of the *L1 GPS Firmware Reference Manual* and in our Price List available from the Sales side menu of our website at [www.novatel.com](http://www.novatel.com).

---

## 4.1 Communications with the Receiver

Communication with the receiver is straightforward, and consists of issuing commands through the communication ports from an external serial communications device. This could be either a terminal or an IBM-compatible PC that is directly connected to the COM1 serial port of the receiver using a straight serial cable. If you are using a TTL communications device such as a radio modem, connect it to the receiver's COM2 port by means of a radio serial cable. For information about input and output messages that are useful for basic operation of the receiver, refer to the *L1 GPS Firmware Reference Manual*. See also the *StarView* examples in *Section 4.2, Getting Started* starting on *Page 29*.

### 4.1.1 Serial Port Default Settings

The receiver communicates with your PC or terminal through a serial port. For communication to occur, both the receiver and the operator interface have to be configured properly. The receiver's COM1 and COM2 default port settings are as follows:

- **9600 bps, no parity, 8 data bits, 1 stop bit, no handshaking, echo off**

Changing the default baud setting requires using *Message ID# 110, Configure COM1 Port Mode* which is described in the *L1 GPS Firmware Reference Manual*. It is recommended that you become thoroughly familiar with the input and output messages detailed in the above reference manual to ensure maximum utilization of the receiver's capabilities.

---

☒ The default data transfer rate is 9600 bps unless your receiver model has Carrier Phase Output (CP) capability in which case it may be 19200. A list of models is in *Appendix A* of the *L1 GPS Firmware Reference Manual* and in our Price List available from the Sales side menu of our website at [www.novatel.com](http://www.novatel.com).

---

The data transfer rate you choose will determine how fast information is transmitted. Take for example a message whose byte count is 96. The default port settings will allow 10 bits/byte. It will therefore take 960 bits per message. To get 10 messages per second then will require 9600 bps. Please also remember that even if you set the bps to 9600 the actual data transfer rate will be less and depends on the number of satellites being tracked, filters in use, and idle time. It is therefore suggested that you leave yourself a margin when choosing a data rate.



**CAUTION:** Although the receiver can operate at data transfer rates as low as 300 bps, this is not desirable. For example, if several data messages are active (that is, a significant amount of information needs to be transmitted every second) but the bit rate is set too low, data overflows the serial port buffers, causes an error condition in the receiver status and results in lost data.

---

## 4.2 Getting Started

Included with your receiver is NovAtel's *StarView* program. *StarView* is a Windows-based graphical user interface which allows you to access the receiver's many features without struggling with communications protocol or writing special software. The information is displayed in windows accessed from the Window menu. For example, to show details of the GPS satellites being tracked, select Satellites | Status from the Window menu. Select Navigation | LLH Solution from the Window menu to display the position of the receiver in LLH (latitude, longitude and height) coordinates.

The receiver is in Navigation mode whenever sufficient satellite information and measurement data is available to produce a GPS fix. When the receiver has a valid position, the *Nav Mode* field in *StarView's LLH Solution*,

or *XYZ Solution*, window shows Nav 3-D, Diff. 3-D or Dead Reckoning. If it shows Initialized there is no valid position yet.

The FlexPak-SSII uses a comprehensive message interface. Input messages can be sent to the receiver using the Xmit Msg menu in StarView.

The following information is important when selecting commands:

1. Message requests are only output to the receiver in binary format. They may however be viewed in ASCII format through *StarView* windows.
2. You can send a message request using one shot (normal mode) or continuous (special mode) by selecting *Xmit Msg | General Message Request* in *StarView*.
3. There is an option in *StarView* to save all messages transmitted by the receiver into a file. Select *File/Port | Save Data* after you have finished selecting messages in Step #2 above.

The L1 *GPS Firmware Reference Manual* provides the available messages and parameters that the SUPERSTAR II uses. See also *Section B.3, StarView Software Installation* starting on *Page 55* and refer to the *StarView User Manual* for more information on the *StarView* program.

The receiver's software resides in read-only memory. As such, the unit "self-boots" when turned on and undergoes a complete self-test, see *Section 4.5.2, Operational States* starting on *Page 31*. If a persistent error develops, please contact your local NovAtel dealer first. If the problem is still unresolved, please contact NovAtel directly through any of the methods in the *Customer Service* section at the beginning of this manual on *Page 9*.

### 4.2.1 Power-Up Information

At power up, the receiver sends two categories of factory information data to COM1 at 9600 bps. The categories of information, Boot and Operational information, can be displayed on a dummy terminal.

### 4.2.2 Boot Information

The Boot information contains the following factory data:

```
SUPERSTAR II
V4
G: XXXXXXXXXXXX
169-613914-007 : Boot S/W Part Number
D0
PCPB: XXXXXXXXXXXX
GO : Go in Operational Mode
```

### 4.2.3 Operational Information

The Operational information contains both the factory and the current operating mode information. The current operating mode baud rate is output twice. This is useful when the operating baud rate is not 9600.

**Example:**

```
<Part Nb:169-614110-XXX1, CB=0x0000003F2 SHP
Go to Binary @ 19200 baud
In Binary @ 19200 baud3
I>3
```

- 
1. Operational S/W Part Number
  2. Power-up BIT result.
  3. Line transmitted at the Configured Baud Rate

## 4.3 Data Requests

Data may be requested for output by the receiver for display or logging purposes. The list of data request commands and data messages is detailed in the *LI GPS Firmware Reference Manual*.

## 4.4 Configurable Parameters

Several parameters of the receiver and the base station are configurable and therefore, you must define them prior to operation.

- 
- ☒ Your receiver must be a BASE model to act as a base station. A list of models is in *Appendix A* of the *LI GPS Firmware Reference Manual* and in our Price List available from the Sales side menu of our website at [www.novatel.com](http://www.novatel.com).
- 

### 4.4.1 Mask Angle

The mask angle is defined as the minimum satellite elevation angle (in degrees) above which any given satellite must be in order for it to be used in the GPS position solution. Low satellites usually do not yield accurate measurements due to weak signal reception and possible multipath. Typical mask angle values range from 5°-10°, depending on the receiver's location. This value is programmable using command *Message ID# 81, Set Mask Angle*.

### 4.4.2 GPS Antenna Position

For the base station, it is imperative to fix the position. This can be done using either the X-Y-Z coordinates in meters within the WGS-84 reference frame, or latitude and longitude in degrees and height in meters (LLH coordinates) by selecting *Tool Setting | Set Operating Mode* in the main menu of *StarView*.

You can also set the X-Y-Z coordinates using *Message ID# 80, Set User's Position/Operating Mode*.

## 4.5 Receiver States

### 4.5.1 Non-Operational State

The receiver's non-operational state is OFF mode. In OFF mode, only the data contained in the NVM is retained for use when power is re-applied. See *Section 3.5, Protocol Selection and Non Volatile Memory* starting on *Page 24* for details on retained data. A supercap allows the SUPERSTAR II to maintain data and time during OFF mode for a period of 3 days to a week.

### 4.5.2 Operational States

The receiver has 6 operating modes:

- Self-Test
- Initialization
- Acquisition
- Navigation
- Dead-Reckoning
- Fault

The receiver switches between modes automatically. The receiver reports on its host port the current operating and navigation modes.

### 1. Self-Test Mode

The receiver enters Self-Test mode upon request from an external source (please refer to *Message ID# 51, Initiated BIT* in the *L1 GPS Firmware Reference Manual*). The time duration spent in the Self-Test mode is no more than 15 seconds. On self-test completion, the receiver reports the BIT results on its host port through Message ID# 51. Self-Test mode exits to either Initialization or Fault mode.

### 2. Initialization Mode

Upon power-up, the receiver enters Initialization mode. During this mode hardware is initialized prior to Acquisition mode entry. The Initialization mode is also initiated upon completion of the Self-Test mode, but always exits to the Acquisition mode.

When the receiver is in OFF mode, it will retrieve data only from NVM (cold start) or from both NVM and SRAM (warm start). Integrity checking is done on all data retrieved from the non-operating state. See also *Section 4.5.1, Non-Operational State* above.

During initialization, the receiver retrieves the last received valid almanac data and last user position from NVM, the current time from the low-power time source, and predicts which satellites are currently visible. This list of visible satellites is then used in Acquisition mode to program the 12 parallel correlator channels.

### 3. Acquisition Mode

The receiver is in Acquisition mode when insufficient satellite data is available to produce an initial navigation solution. Acquisition mode is entered from Initialization, or Dead-Reckoning mode, and exits to Navigation or Fault mode.

To acquire signals from the GPS satellites, the receiver uses:

- Almanac data which describes the satellite orbits
- Time, which in conjunction with almanac data is used to estimate the present position of satellites in their orbits
- The approximate location of the receiver so a prediction can be made as to which satellites are visible

The receiver then collects ephemeris data by decoding the satellite down-link data message. After each satellite in view is acquired, its measurement data set is produced. When a sufficient number of satellites are being tracked, position, velocity and time can be computed and Navigation mode entered.

If the receiver cannot perform an acquisition due to an absence of valid almanac data or user position and/or time, it initiates a "Search the Sky" acquisition. The receiver attempts to acquire all satellites in the GPS constellation. Once a satellite has been acquired, ephemeris data is decoded from the satellite down-link message. After sufficient satellites have been acquired, the receiver enters Navigation mode. In "Search the Sky", the TTFF is typically less than 3 minutes.

### 4. Navigation Mode

The receiver is in Navigation mode whenever sufficient satellite information and measurement data is available to produce a GPS fix. Navigation mode is entered from Acquisition or Dead-Reckoning mode, and exits to Dead-Reckoning or Fault mode.

In Navigation mode, a receiver configured as a roving unit operates in 2 sub-modes: Differential and Stand-Alone Nav. Sub-mode transition occurs automatically depending on satellite data availability. A receiver which is configured as a base station unit will operate in Base Station Nav



mode only. The receiver reports its current navigation sub-mode on its host port.

- 
- ☒ Your receiver must be a BASE model to act as a base station. A list of models is in *Appendix A* of the *L1 GPS Firmware Reference Manual* and in our Price List available from the Sales side menu of our website at [www.novatel.com](http://www.novatel.com).
- 

a. Differential (Roving Unit Only)

The receiver operates in Differential mode when data from at least 4 satellites with adequate geometry and differential corrections and/or measurements exist to compute position, velocity and time outputs. This is the preferred navigation mode. Differential data is supplied to the receiver through the differential input port. Differential data can be received only on the COM2 serial data port.

b. Stand-Alone Nav (Roving Unit Only)

The receiver operates in Stand-Alone Nav mode when it has data from at least 4 satellites with adequate geometry, but no differential corrections or measurements, exist to compute position, velocity and time outputs. This is the preferred navigation mode when insufficient differential data is available to generate a differential GPS fix.

c. Base Station Nav (Base Station Unit Only)

The receiver operates in Base Station Nav mode once the time has been initialized and at least 4 satellites with adequate geometry can be used for navigation purposes. Once in this mode, only a change of configuration (rover mode requested) or a reset will cause the unit to leave this navigation mode. In this mode, the unit will have the ability to transmit the DGPS messages which are requested and allowed once its position is initialized. See also *Section 4.4, Configurable Parameters* starting on *Page 31* for position initialization details.

#### 5. Dead-Reckoning Mode

The receiver enters Dead-Reckoning mode when it cannot remain in Navigation mode. The speed and direction is assumed to be constant to allow the receiver to provide an estimated position.

#### 6. Fault Mode

The receiver enters Fault mode during the period of time in which the receiver outputs are affected by one or more critical system faults. This mode supersedes all others and remains active until the next power-down/power-up cycle. Fault mode is entered from any mode except Initialization.

## 4.6 Built-In Status Tests

The receiver performs self-tests and generates status information to provide an indication of the operational readiness and to facilitate maintenance actions.

The built in test monitors system performance and status to ensure the receiver is operating within its specifications. If an exceptional condition is detected, you are informed through one or more indicators. The receiver status system is used to configure and monitor these indicators:

- *Message ID# 49, Receiver Status Data*
- *Message ID# 51, Initiated BIT Result*
- Status LED on the FlexPak-SSII

Please refer to the *L1 GPS Firmware Reference Manual* for details on the Message IDs above. See also *Section 4.5.2, Operational States* starting on *Page 31* and status LED information may be found in this manual on *Page 50*.

## 4.7 DATUM Support

The receiver has the ability to provide its position in one of the 62 predefined datums. The list of the supported datum and details on *Message ID# 88, Select/Define Datum to Use* are provided in the *L1 GPS Firmware Reference Manual*. The receiver can also support two user-defined datums. You must define them, prior to their use, using *Message ID# 88*. Afterwards, the desired datum, whether it is user-defined or predefined, can be selected using the above message.

The chapter discusses the industry-standard message formats that can be used with your SUPERSTAR II receiver, including RTCM and NMEA. Refer to the *L1 GPS Firmware Reference Manual* for more information on using these message formats.

## 5.1 RTCM-Format Messages

The Radio Technical Commission for Maritime Services (RTCM) was established to facilitate the establishment of various radio navigation standards, which includes recommended GPS differential standard formats.

The standards recommended by the Radio Technical Commission for Maritime Services Special Committee 104, Differential GPS Service (RTCM SC-104, Washington, D.C.), have been adopted by NovAtel for implementation into the receiver. Because the receiver is capable of utilizing RTCM formats, it can easily be integrated into positioning systems around the globe.

As it is beyond the scope of this manual to provide in-depth descriptions of the RTCM data formats, it is recommended that anyone requiring explicit descriptions of such, should obtain a copy of the published RTCM specifications. See *Appendix D, Standards/References on Page 62* for reference information.

*Message ID# 83, DGPS Configuration* contains one or part of a RTCM message. The message type selected in the Set DGPS Configuration message (Message ID# 83, bytes 9 to 16) is retransmitted through this message. Message length is variable and a message can be transmitted up to once every 100 ms. A RTCM message always starts as the first byte of a message and always ends as the last byte of a message. Thus, a RTCM message can be output in one or many messages but a message block cannot contain more than one RTCM message. The control byte is used to determine the start and the end of a RTCM message. The sequence number of the control byte can be used to detect the loss of a message block on the transmitter side. It starts at 0 and increments by one for each consecutive message block (0,1,2,3,0,1,2,3,0,1,...). Refer also to the *L1 GPS Firmware Reference Manual* for details on this message.

All receiver messages adhere to the structure recommended by RTCM SC-104. Thus, all RTCM messages are composed of 30 bit words. Each word contains 24 data bits and 6 parity bits. All RTCM messages contain a 2-word header followed by 0 to 31 data words for a maximum of 33 words (990 bits) per message.

Message Frame Header	Data	Bits
Word 1	– Message frame preamble for synchronization	8
	– Frame/message type ID	6
	– Base station ID	10
	– Parity	6
Word 2	– Modified z-count (time tag)	13
	– Sequence number	3
	– Length of message frame	5
	– Base health	3
	– Parity	6

The remainder of this section will provide further information concerning receiver RTCM data formats.

### 5.1.1 RTCM1 Differential GPS Corrections (Fixed)

This is the primary RTCM message used for pseudorange differential corrections. This message follows the RTCM Standard Format for a Type 1 message. It contains the pseudorange differential correction data

computed by the base station generating this Type 1 message. The message is of variable length, depending on the number of satellites visible and pseudorange corrections by the base station. Satellite specific data begins at word 3 of the message.

Type 1 messages contain the following information for each satellite in view at the base station:

- Satellite ID
- Pseudorange correction
- Range-rate correction
- Issue of Data (IOD)

When operating as a base station, the receiver's position must be set using *Message ID# 80, Set User's Position/Operating Mode*. When operating as a rover station, the receiver COM port receiving the RTCM data must be set to Rover mode using command Message ID# 80. Please refer to the *L1 GPS Firmware Reference Manual* for more details on this input message.

### 5.1.2 RTCM2 Delta Differential GPS Corrections (Fixed)

Quite often a base station may have new ephemeris data before rover stations have collected the newer ephemeris. The purpose of Type 2 messages is to act as a bridge between old and new ephemeris data. A base station will transmit this Type 2 bridge data concurrently with Type 1's for a few minutes following receipt of a new ephemeris. The rover station adds the Type 2 data (delta of old ephemeris minus new ephemeris) to the Type 1 message data (new ephemeris) to calculate the correct pseudorange corrections (based on the old ephemeris). Once the rover receiver has collected its own updated ephemeris, it will no longer utilize the Type 2 messages.

The GPS Card will accept and decode RTCM Standard Type 2 messages, when available and if required.

Type 2 messages are variable in length, depending on the number of satellites being tracked by the base station.

### 5.1.3 RTCM9 Partial Satellite Set Differential Corrections

RTCM Type 9 messages follow the same format as Type 1 messages. However, unlike a Type 1 message, Type 9 does not require a complete satellite set. This allows for much faster differential correction data updates to the rover stations, thus improving performance and reducing latency.

Type 9 messages should give better performance with slow or noisy data links.

- 
- ☒ The base station transmitting the Type 9 corrections must be operating with a high-stability clock to prevent degradation of navigation accuracy due to the unmodeled clock drift that can occur between Type 9 messages. For this reason, only receivers with an external oscillator can generate Type 9 messages. SUPERSTAR II receivers can accept Type 9 messages.

NovAtel recommends a high-stability clock such as the PIEZO Model 2900082 whose 2-sample (Allan) variance meets the following stability requirements:

$$3.24 \times 10^{-24} \text{ s}^2/\text{s}^2 \text{ between } 0.5 - 2.0 \text{ seconds, and}$$

$$1.69 \times 10^{-22} \text{ T s}^2/\text{s}^2 \text{ between } 2.0 - 100.0 \text{ seconds}$$

An external clock, such as an OCXO, requires approximately 10 minutes to warm up and become fully stabilized after power is applied; do not broadcast RTCM Type 9 corrections during this warm-up period.

---

Type 9 messages contain the following information for a group of three satellites in view at the base station:

- Scale factor
- User Differential Range Error
- Satellite ID
- Pseudorange correction
- Range-rate correction
- Issue of Data (IOD)

## 5.2 NMEA Format Data Messages

The NMEA log structures follow format standards as adopted by the National Marine Electronics Association. The reference document used is "Standard For Interfacing Marine Electronic Devices NMEA 0183 Version 2.00". For further information, see *Appendix D, Standards/References on Page 62*. The following table contains excerpts from Table 6 of the NMEA Standard which defines the variables for the NMEA messages. The actual format for each parameter is indicated after its description.

Field Type	Symbol	Definition
<b>Special Format Fields</b>		
Status	A	Single character field: A = Yes, Data Valid, Warning Flag Clear V = No, Data Invalid, Warning Flag Set
Latitude	lll.ll	Fixed/Variable length field: degrees minutes.decimal - 2 fixed digits of degrees, 2 fixed digits of minutes and a <u>variable</u> number of digits for decimal-fraction of minutes. Leading zeros always included for degrees and minutes to maintain fixed length. The decimal point and associated decimal-fraction are optional if full resolution is not required.
Longitude	yyyyy.yy	Fixed/Variable length field: degrees minutes.decimal - 3 fixed digits of degrees, 2 fixed digits of minutes and a <u>variable</u> number of digits for decimal-fraction of minutes. Leading zeros always included for degrees and minutes to maintain fixed length. The decimal point and associated decimal-fraction are optional if full resolution is not required
Time	hhmmss.ss	Fixed/Variable length field: hours minutes seconds.decimal - 2 fixed digits of hours, 2 fixed digits of minutes, 2 fixed digits of seconds and <u>variable</u> number of digits for decimal-fraction of seconds. Leading zeros always included for hours, minutes and seconds to maintain fixed length. The decimal point and associated decimal-fraction are optional if full resolution is not required.
Defined field		Some fields are specified to contain pre-defined constants, most often alpha characters. Such a field is indicated in this standard by the presence of one or more valid characters. Excluded from the list of allowable characters are the following which are used to indicate field types within this standard: "A", "a", "c", "hh", "hhmmss.ss", "lll.ll", "x", "yyyyy.yy"
<b>Numeric Value Fields</b>		
Variable numbers	x.x	Variable length integer or floating numeric field. Optional leading and trailing zeros. The decimal point and associated decimal-fraction are optional if full resolution is not required (example: 73.10 = 73.1 = 073.1 = 73)
Fixed HEX	hh__	Fixed length HEX numbers only, MSB on the left
<b>Information Fields</b>		
Variable text	c--c	Variable length valid character field.
Fixed alpha	aa__	Fixed length field of uppercase or lowercase alpha characters
Fixed number	xx__	Fixed length field of numeric characters
Fixed text	cc__	Fixed length field of valid characters
<b>NOTES:</b>		
<ol style="list-style-type: none"> <li>1. Spaces may only be used in variable text fields.</li> <li>2. A negative sign "-" (HEX 2D) is the first character in a Field if the value is negative. The sign is omitted if value is positive.</li> <li>3. All data fields are delimited by a comma (,).</li> <li>4. Null fields are indicated by no data between two commas (,). Null fields indicate invalid or no data available.</li> <li>5. The NMEA Standard requires that message lengths be limited to 82 characters.</li> </ol>		

The following single frequency modes of operation are described further in this chapter:

- Single Point or Autonomous
- Satellite-Based Augmentation System (SBAS)

See *Appendix G, GPS Overview on Page 67* for an overview of GPS positioning.

## 6.1 Single-Point or Autonomous

The NovAtel SUPERSTAR II receiver is capable of absolute single-point positioning accuracies of < 5 meters CEP (GDOP < 2; no multipath).

The general level of accuracy available from single-point operation may be suitable for many types of applications that do not require position accuracies of better than 5 m CEP. However, increasingly more and more applications desire and require a much higher degree of accuracy and position confidence than is possible with single-point pseudorange positioning. This is where differential GPS (DGPS) plays a dominant role in higher accuracy real-time positioning systems, see also *Section G.3, GPS Positioning on Page 69*.

By averaging many GPS measurement epochs over several hours, it is possible to achieve a more accurate absolute position.

The next section deals with the type of GPS system errors that can affect accuracy in single-point operation.

### 6.1.1 GPS System Errors

In general, GPS SPS C/A code single-point pseudorange positioning systems are capable of absolute position accuracies of about 5 meters or less. This level of accuracy is really only an estimation, and may vary widely depending on numerous GPS system biases, environmental conditions, as well as the GPS receiver design and engineering quality.

There are numerous factors which influence the single-point position accuracies of any GPS C/A code receiving system. As the following list will show, a receiver's performance can vary widely when under the influences of these combined system and environmental biases.

- **Ionospheric Group Delays** – The earth's ionospheric layers cause varying degrees of GPS signal propagation delay. Ionization levels tend to be highest during daylight hours causing propagation delay errors of up to 30 meters, whereas night time levels are much lower and may be as low as 6 meters.
- **Tropospheric Refraction Delays** – The earth's tropospheric layer causes GPS signal propagation delays. The amount of delay is at the minimum (about three metres) for satellite signals arriving from 90 degrees above the horizon (overhead), and progressively increases as the angle above the horizon is reduced to zero where delay errors may be as much as 50 metres at the horizon.
- **Ephemeris Errors** – Some degree of error always exists between the broadcast ephemeris' predicted satellite position and the actual orbit position of the satellites. These errors will directly affect the accuracy of the range measurement.
- **Satellite Clock Errors** – Some degree of error also exists between the actual satellite clock time and the clock time predicted by the broadcast data. This broadcast time error will cause some bias to the pseudorange measurements.
- **Receiver Clock Errors** – Receiver clock error is the time difference between GPS receiver time and true GPS time. All GPS receivers have differing clock offsets from GPS time that vary from receiver to receiver by an unknown amount depending on the oscillator type and quality (TCXO verses

OCXO, and so on).

- **Multipath Signal Reception** – Multipath signal reception can potentially cause large pseudorange and carrier phase measurement biases. Multipath conditions are very much a function of specific antenna site location versus local geography and man-made structural influences. Severe multipath conditions could skew range measurements by as much as 100 meters or more.

## 6.2 Satellite-Based Augmentation System (SBAS)

A Satellite-Based Augmentation System (SBAS) is a type of geo-stationary satellite system that improves the accuracy, integrity, and availability of the basic GPS signals. Accuracy is enhanced through the use of wide area corrections for GPS satellite orbits and ionospheric errors. Integrity is enhanced by the SBAS network quickly detecting satellite signal errors and sending alerts to receivers to not use the failed satellite. Availability is improved by providing an additional ranging signal to each SBAS geostationary satellite.

SBAS includes the Wide-Area Augmentation System (WAAS), the European Geo-Stationary Navigation System (EGNOS), and the MTSAT Satellite-Based Augmentation System (MSAS). At the time of publication, there are two WAAS satellites over the western Atlantic Ocean and the Pacific (PRN 122 and PRN 134 respectively) and one EGNOS satellite over the eastern Atlantic Ocean (PRN 120). SBAS data is available from any of these satellites and more satellites will be available in the future.

The primary functions of SBAS include:

- data collection
- determining ionospheric corrections
- determining satellite orbits
- determining satellite clock corrections
- determining satellite integrity
- independent data verification
- SBAS message broadcast and ranging
- system operations & maintenance

As shown in *Figure 7, The SBAS Concept*, the SBAS is made up of a series of Reference Stations, Master Stations, Ground Uplink Stations and Geostationary Satellites (GEOs). The Reference Stations, which are geographically distributed, pick up GPS satellite data and route it to the Master Stations where wide area corrections are generated. These corrections are sent to the Ground Uplink Stations which up-link them to the GEOs for re-transmission on the GPS L1 frequency. These GEOs transmit signals which carry accuracy and integrity messages, and which also provide additional ranging signals for added availability, continuity and accuracy. These GEO signals are available over a wide area and can be received and processed by L1 GPS receivers with appropriate firmware. GPS user receivers are thus able to receive SBAS data in-band and use not only differential corrections, but also integrity, residual errors and ionospheric information for each monitored satellite.

The signal broadcast through the SBAS GEOs to the SBAS users is designed to minimize modifications to standard GPS receivers. As such, the GPS L1 frequency (1575.42 MHz) is used, together with GPS-type modulation - e.g. a Coarse/Acquisition (C/A) pseudorandom (PRN) code. In addition, the code phase timing is

maintained close to GPS time to provide a ranging capability.

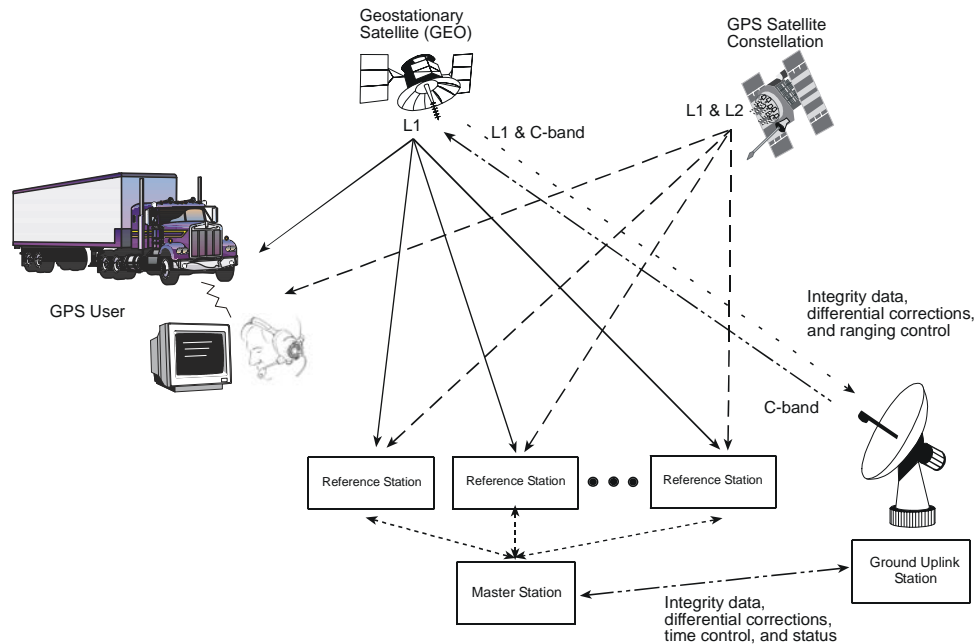

Figure 7: The SBAS Concept

### 6.2.1 SBAS Receiver

NovAtel SUPERSTAR II-based receivers are equipped with an SBAS feature. The ability to simultaneously track two SBAS satellites, and incorporate the SBAS corrections into the position, is available in these models.

These models can output the SBAS data in log format (refer to *Message ID# 67, WAAS Data* in the *L1 GPS Firmware Reference Manual*), and can incorporate these corrections to generate differential-quality position solutions. Standard SBAS data messages are analyzed based on RTCA standard DO-229B Change 1 Minimum Operational Performance Standards for GPS/WAAS airborne equipment.

A SBAS-capable receiver will permit anyone within the area of coverage to take advantage of its benefits.

### 6.2.2 SBAS Messages

The command *Message ID# 95, Track SV*, enables the use of particular SBAS corrections in the position filter. Two SBAS-specific messages:

*Message ID# 67, SBAS Data*

*Message ID# 68, SBAS Status*

are also available. In order to use these messages, first ensure that your receiver is capable of receiving SBAS corrections.

*StarView* allows you to deselect GPS and SBAS system satellites. Select *Tool Settings / Deselect / SVs* from the main menu. To track one SBAS satellite in particular, do the following:

1. Select *SBAS SVs*
2. Select the SBAS satellite that you wish to track by deselecting all the others. This ensures that the receiver will search for a satellites that is known to be operating and thus a quick acquisition/re-acquisition of the active SBAS satellite.
3. By default, if you select *SBAS SVs* alone, the unit is only searching for satellite PRNs 120, 122 and



134.

4. Select *Status / SBAS* from the *Window* menu to see the number of valid SBAS messages that are being decoded for a specific SV number since the last power-up. When the Valid Messages count is not incrementing, it means that either the receiver is not tracking any SBAS satellites, or it is unable to demodulate the SBAS bit stream.

Refer to the *L1 GPS Firmware Reference Manual* for more details on individual SBAS messages that use the SBAS corrections and for an appendix on *SBAS Positioning* that includes an explanation of dynamic modes. Refer also to *Message ID# 30, Receiver Configuration* in the same manual.

When your receiver appears not to be working properly, often there are simple ways to diagnose and resolve the problem. In many cases, the issue can be resolved within a few minutes, avoiding the hassle and loss of productivity that results from having to return your receiver for repair. This chapter is designed to assist you in troubleshooting problems that occur and includes resolutions to aid your receiver in becoming operational.

If you are unsure of the symptoms or if the symptoms do not match any of those listed, use *Message ID# 51, Initiated BIT* and refer to its description in the *L1 GPS Firmware Reference Manual*.

If the problem is not resolved after using this troubleshooting guide, contact Customer Service, see *Page 9*.

This section is intended to assist you in the use of our SUPERSTAR II product.

1. If you are having problems communicating with the SUPERSTAR II product:
  - Verify connection: look for broken pins, a misaligned connector or intermittent contact.
  - Verify power supply input is acceptable e.g. at a good level, low ripple, and not noisy.
  - Verify the Receive/Transmit ports are going to the correct ports on the host computer. Check signal directions and voltage levels.
  - Verify communication settings match the host computer for both protocol and baud rate.
2. If you are experiencing problems with low SNR levels:
  - Verify antenna connector, look for broken or poor connections on the RF signal/shield contacts.
  - If using an active antenna, verify antenna is receiving correct power from RF connector; preamp input into SUPERSTAR II is feeding a DC bias on the center conductor.
  - Verify cable length from the antenna to SUPERSTAR II; signal will be attenuated based on this length. For best performances, ensure the gain at the input of the receiver is between -3 dB and 8 dB, see *Table 6* below (for RG-58/U LLDS80 cables):

**Table 6: Cable Lengths Vs. Gain**

Antenna Gain	Min Cable Length (Loss)	Max Cable Length (Loss)	Signal Level at Input
0 dB	0m (0 dB)	3m (3 dB)	0 dB / -3 dB
+12 dB	5m (4 dB)	25m (15 dB)	8 dB / -3 dB
+26 dB	30m (18 dB)	54m (31 dB)	8 dB / -3 dB
+36 dB	49m (28 dB)	69m (39 dB)	8 dB / -3 dB

- Check antenna's installation, verify there is a clear view of the sky (i.e. no obstructions) and there is no reflective surface nearby that may cause multipath interferences.
  - Verify the effectiveness of your EMI / EMC shielding. Close proximity to high energy sources (both digital & RF circuitry) can affect your SUPERSTAR II's performance.
  - Verify the cleanness (i.e. low ripple, minimum noise spikes, voltage level variations) of the power source. Isolate the power supply of the SUPERSTAR II from the main system power.
  - Check digital, RF and power ground returns. Look for noise being coupled on ground return paths.
3. If you are not receiving differential corrections:
    - Check DGPS connection on COM2 (port #2) of the SUPERSTAR II.
    - Verify DGPS source settings are active.

- Verify DGPS base station is actually transmitting DGPS corrections and base data is being received by the SUPERSTAR II.
4. If you are not receiving expected messages from the SUPERSTAR II:
- Verify transmit message settings (i.e. receiver's output configuration or requested message).
  - Verify hardware and software part numbers are as per expected configuration.
  - Restore default settings by sending an *Erase NVM* command (*Message ID# 99, Erase NVM*) to the SUPERSTAR II
  - Read the Reference Manual - refer to the *L1 GPS Firmware Reference Manual* describing message contents.

For the problems above you may be able to isolate the suspected unit in your application:

- Substitute another SUPERSTAR II.
- Substitute another host hardware.
- Substitute another RF source (i.e. antenna, cable).
- Substitute another interconnect harness.
- Substitute alternate power source or isolate main power source from auxiliary power source for SUPERSTAR II.
- Make intermittent problems more repeatable (i.e. by raising operating temperature, varying power supply source, re-orienting hardware placement). Be sure to note what makes the problem worse / lessens the problem.

Having gone through the steps in this chapter and, if possible, the substitutions above, contact Customer Service (see *Page 9*).

- Describe your problem, be sure to include observations, symptoms and environmental conditions for your application.
- Please supplement your problem / event descriptions with associated log files.
- Give hardware part number and software part numbers (including installed configurations).
- Customer support staff will give you instructions if the unit needs to be returned to the factory.

## A.1 SUPERSTAR II Family Performance

<b>PERFORMANCE*</b>	
<b>Position Accuracy:</b>	DGPS <1 m (CEP) Single Point <5 m (CEP) SBAS <1.5 m (CEP)
<b>Time to First Fix:</b>	Hot start: 15 s typical, with current almanac, position, time and ephemeris Warm start: 45 s typical, with current almanac, position and time Cold start: 2 min. typical, no almanac, no position and no time
<b>Signal Re-Acquisition:</b>	< 1 s (typical) (5 second obscuration)
<b>Dynamics:</b>	
<b>Velocity:</b>	514 m/s (limited by US and Canadian export laws)
<b>Acceleration:</b>	4 G (39.2 m/s <sup>2</sup> )
<b>Jerk:</b>	2 m/s <sup>3</sup>
<b>Altitude:</b>	18 km (60,000 ft.) (limited by US and Canadian export laws)

## A.2 SUPERSTAR II GPS Card

<b>GENERAL CHARACTERISTICS*</b>	
<b>12-PARALLEL "ALL-IN-VIEW" TRACKING</b> SBAS Support (for example WAAS and EGNOS)	
<b>L1 Frequency:</b>	1,575.42 MHz
<b>Minimum Tracking Sensitivity:</b>	-135 dBm (antenna input level)
<b>HARDWARE SPECIFICATIONS*</b>	
<b>Input Voltage:</b>	+3.3 VDC or +5.0 VDC
<b>Power Consumption</b>	0.8 W typical at 5.0 VDC with a passive antenna 0.5 W typical at 3.3 VDC with a passive antenna
<b>RF Input</b>	MCX connector, 50 Ω impedance
<b>Operational Signal Level Input</b>	-165 dBw to -120 dBw
<b>"Keep Alive" Mode:</b>	Input voltage 2.5 to 4.5 VDC Current draw < 1 mA (5V) < 50 μA (RTC only)
<b>Serial Communications:</b>	2 x TTL level asynchronous data ports from 300 up to 19 200 bps)

<b>Input Messages:</b>	COM1: NMEA or proprietary binary COM2: RTCM SC-104 types 1, 2, and 9
<b>Output Messages:</b>	COM1: NMEA or proprietary binary (NMEA types GGA, GSA, GSV, RMC, ZDA, GLL plus proprietary messages)
<b>Time Mark Output:</b>	1PPS, aligned with GPS time ( $\pm 200$ ns typical in absolute mode) Discrete: 3 general purpose input/output lines
<b>PHYSICAL AND ENVIRONMENTAL*</b>	
<b>Dimensions:</b>	46 x 71 x 13 mm
<b>Weight:</b>	22 g
<b>Operating Temperature:</b>	-30°C to +75°C
<b>Storage Temperature:</b>	-55°C to +90°C
<b>Humidity:</b>	5% to 95% relative humidity, non-condensing to +60°C
<b>SUPERSTAR II DEVELOPMENT KIT*</b>	
<b>Input Voltage:</b>	+6 to +18 VDC
<b>Waterproof Connectors:</b>	Power: 3-pin (Deutsch part number: 58064-08-98SN) COM1: 13-pin (Deutsch part number: 59064-11-35SF) COM2: 13-pin (Deutsch part number: 59064-11-35SF) RF Input: Female TNC
<b>Accessories Included:</b>	A FlexPak-SSII enclosure containing a SUPERSTAR II receiver (see <i>Appendix B</i> starting on <i>Page 49</i> ) A +12 dB active GPS antenna with a magnetic mount and a 6 m RF cable Power cable with an automotive adapter Null-modem serial cable with DB-9 connector

\* Specifications are subject to change without notice

### A.2.1 Mechanical Drawing

Figure 8 shows the SUPERSTAR II OEM board outline.

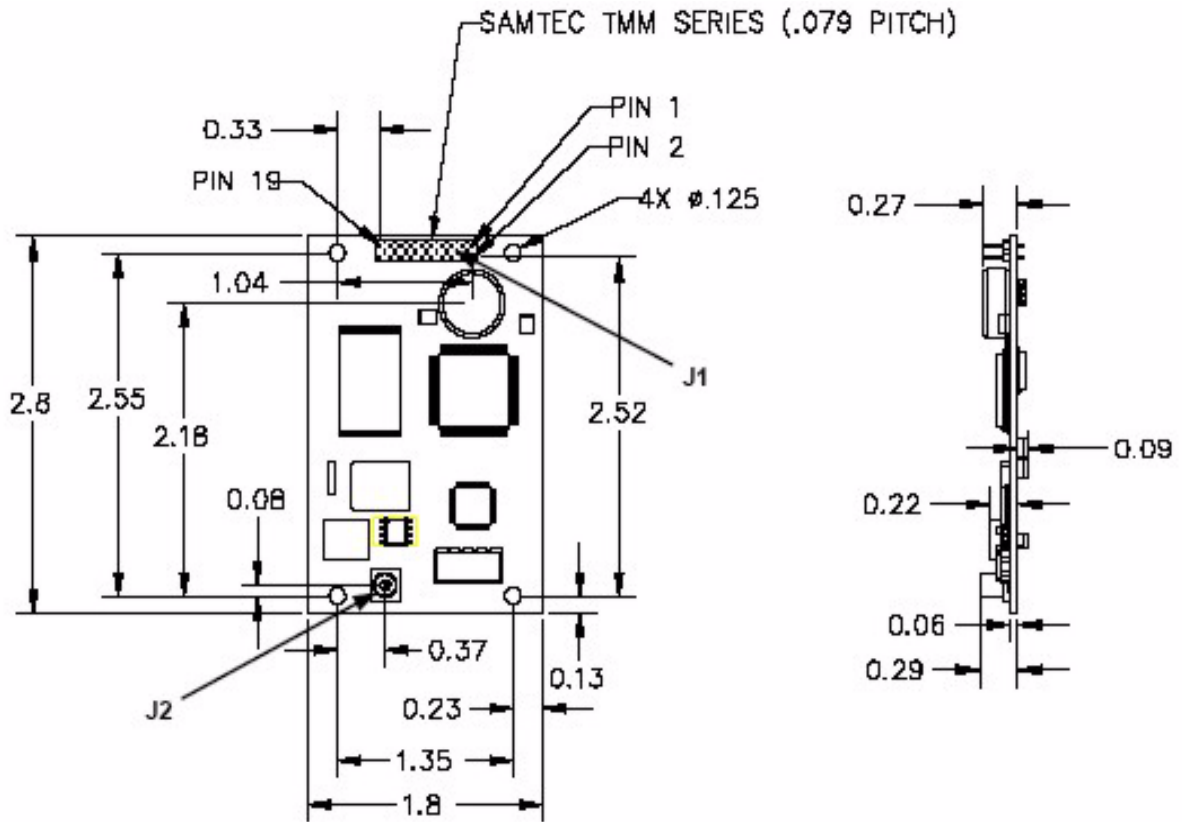

Dimensions are shown in inches  
 Tolerance: 0.XX = +/- 0.01 0.XXX = +/- 0.007

Figure 8: SUPERSTAR II Dimensions

### A.2.2 Connector Pin Assignment

Table 7 shows the Interface and Power connector J1 pin assignment.

**Table 7: J1 Interfaces and Power Connector Pin Assignment**

J1 PIN #	SIGNAL NAME	FUNCTION
1	PREAMP	Power for active antenna (40 mA max)
2	VCC	Primary power (3.3V or 5.0V -0.5 V/+0.25 V)
3	VBATT	Back-up battery for real-time clock device (external series diode required)
4	RX_NO_3/DISC_IO_3	Serial port Rx #3/ Programmable discrete I/O pin (expansion pin for special applications)
5	MASTER_RESET	Reset input pin (active low)
6	DISC_IP_1	Reprogramming control input pin (active high)
7	DISC_IP_2	Protocol select pin (see Section 3.5 on Page 24)
8	DISC_IP_3	NVM control pin (see Section 3.5 on Page 24)
9	DISC_IO_1	Programmable discrete I/O pin (expansion pin for special applications)
10	GND	Ground
11	TX_NO_1	Serial port Tx #1
12	RX_NO_1	Serial port Rx #1
13	GND	Ground
14	TX_NO_2	Serial port Tx #2
15	RX_NO_2	Serial port Rx #2
16	GND	Ground
17	DISC_IO_2	Programmable discrete I/O pin (expansion pin for special applications)
18	GND	Ground
19	TIMEMARK	1PPS output
20	TX_NO_3	Serial port Tx #3

### A.2.3 I/O Electrical Characteristics

Table 8 shows the voltage level limits for the different I/O signals:

**Table 8: I/O Signals Voltage Limits**

SIGNAL NAME	TYPE	Input low max (V)	Input high min (V)	Output low max (V)	Output high min (V)
MASTER_RESET <sup>1</sup>	I	0.50	2.00		
Disc_IP_1, Disc_IP_2, Disc_IP_3, Rx_No_1, Rx_No_2	I	0.8	2.5		
DISC_IO_1, DISC_IO_2	I/O	0.8	2.5	0.4	3.0 I <sub>o</sub> ≤ 200uA
TX_NO_1, TX_NO_2	O			0.4	3 I <sub>o</sub> ≤ 200uA
RX_NO_3/DISC_IO_3	I/O	0.8	2.0	0.4	3.7 I <sub>o</sub> ≤ 200uA
TIMEMARK, TX_NO_3	O			0.4	3.7 I <sub>o</sub> ≤ 200uA

1. A LO pulse of 150 ns minimum will invoke a master reset to the receiver.
2. Conditions: 5 V ± 0.25 V (for all limits)



## B.1 FlexPak-SSII

<b>INPUT/OUTPUT CONNECTORS</b>	
<b>Antenna</b>	Waterproof TNC female jack, 50 Ω nominal impedance +4.25 to +5.25 VDC, 90 mA max (output from FlexPak to antenna/LNA)
<b>Power</b>	3-pin waterproof Deutsch connector (Deutsch PN 59065-09-98PN) Input Voltage: +6 to +18 VDC      Power Consumption: 0.7 W (typical)
<b>COM1</b>	13-pin waterproof Deutsch connector (Deutsch P/N 59065-11-35PF)
<b>COM2</b>	13-pin waterproof Deutsch connector (Deutsch P/N 59065-11-35PF)
<b>PHYSICAL</b>	
<b>Size</b>	45 x 147 x 123 mm
<b>Weight</b>	307 g
<b>Mounting System</b>	Integral flange with two 9/32" diameter mounting holes 5-1/4" apart
<b>ENVIRONMENTAL</b>	
<b>Temperature</b>	Operating: -40° C to +75° C      Storage: -40° C to +85° C
<b>Humidity</b>	Not to exceed 95% non-condensing
<b>Waterproof</b>	To IEC 60529 IP X4 and IP X7
<b>DIMENSIONS</b>	

a. Dimensions are in mm

### B.1.1 Status Indicators

The FlexPak-SSII provides the status indicators shown in *Table 9*.

**Table 9: FlexPak Status Indicators**

Indicator	Indicator Color	Status
COM1	Green	Data is being transmitted from COM1
	Red	Data is being received on COM1
COM2	Green	Data is being transmitted from COM2
	Red	Data is being received on COM2
ANT	Green	Valid position computed
PWR	Red	The receiver is powered

### B.1.2 Port Pin-Outs

The pin numbering for each of the ports, is described in *Table 10*.

**Table 10: FlexPak COM Ports Pin-Out Descriptions**

COM1 (Deutsch TTL)		COM2 (Deutsch TTL)	
Connector Pin No.	Signal Name	Connector Pin No.	Signal Name
1	Reserved	1	Reserved
2	RXD1	2	RXD2
3	Reserved	3	Reserved
4	Reserved	4	Reserved
5	GND	5	GND
6	Reserved	6	Reserved
7	Reserved	7	Reserved
8	TX1	8	TXD2
9	Reserved	9	Reserved
10		10	PPS
11		11	Reserved
12		12	DISC_IP1 <sup>a</sup>
13		13	Reserved

a. Leave open or tie to ground for normal operation. Set high for programming mode only.

---

☒ See also *Section 3.4, Connectors and Connector Pins Assignment on Page 22*.

---

### B.1.3 Cables

#### B.1.3.1 Automobile Power Adapter Cable (NovAtel part number 01017374)

The power adapter cable supplied with the FlexPak provides a convenient means for supplying +12 V DC while operating from an automobile. The figure below shows the cable and a wiring diagram of the automobile adapter.

The output of the power adapter uses a 3-pin Deutsch socket (Deutsch part number: 58064-08-98SN). This cable plugs directly into the PWR port on the front of the FlexPak.

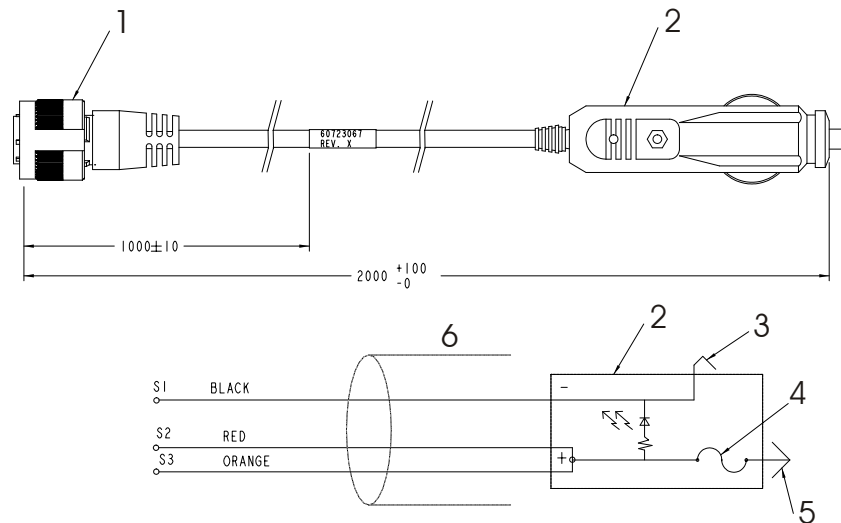

Reference	Description
1	3-pin Deutsch connector
2	Automobile adapter
3	Outer contact
4	3 amp slow-blow fuse
5	Center contact
6	Foil shield



Figure 9: FlexPak Power Cable

**B.1.3.2 13-Pin Deutsch to DB9 Serial Cable (NovAtel part number 01017375)**

The null-modem serial cable shown below provides a means of interfacing between the COM1 or COM2 port on the FlexPak and another serial communications device, such as a PC. At the FlexPak end, the cable is equipped with a 13-pin Deutsch connector (Deutsch part number: 59064-11-35SF), which plugs directly into a COM port. At the other end, a DB9S connector is provided. The cable is 2 meters in length. See also *Section B.1.2, Port Pin-Outs on Page 50*.

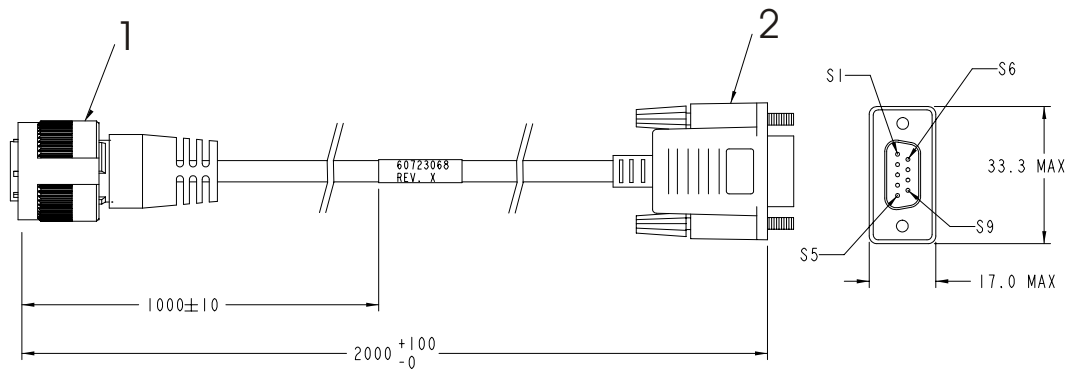

TO RECEIVER	SIGNAL	DB-9 FEMALE TO PC
S1	GPIO	N/C
S2	RXD1	S3
S3	CTS1	S7
S4	EVENT1	N/C
S5	GND	S5
S6	EVENT2	N/C
S7	RTS1	S8
S8	TXD1	S2
S9	POUT	S1, S6
S10	PPS	N/C
S11	Reserved	N/C
S12		N/C
S13	ERROR	N/C

Reference	Description
1	13-pin Deutsch connector
2	DB9S connector



**Figure 10: FlexPak 13-Pin Serial Cable**

## B.2 Development Kit

The SUPERSTAR II Development Kit allows you to easily evaluate the L1 GPS receiver. The Development Kit implements the receiver control operation and I/O functions of the receiver using a PC, a serial cable, an external GPS antenna, and a power cable with a 120 V AC to 12 V DC power adapter. The SUPERSTAR II is contained in the FlexPak-SSII unit, with I/O connectors and status LEDs.

*StarView* is a Windows application running on a PC that allows communication with the receiver. Commands and data requests can be sent through this application and received data is decoded and displayed in specific windows. A data logging facility is also provided within this tool. Details on the use of *StarView* is provided in the *StarView User Manual* (see Reference [5] on Page 13).

This section explains how to configure the Development Kit receiver, and how to interconnect the equipment.

### B.2.1 Description

The Development Kit contains the following equipment:

QTY	DESCRIPTION
1	FlexPak-SSII unit with built in SUPERSTAR II receiver card
1	+12 dB active GPS antenna with 20 ft. cable, see Page 59
1	<i>StarView</i> software and L1 GPS user manuals on CD
1	Serial cable (DB9 connector to 13-pin Deutsch connector), see Page 52
1	Automotive power cable (12 V DC power connector to 3-pin Deutsch connector) and power supply adapter 120 V AC to 12 V DC, see Page 51

### B.2.2 Setup and Operation

- 
- ☒ The default data transfer rate is 9600 bps unless your receiver model has Carrier Phase Output (CP) capability in which case it may be 19200.



Your receiver must be a BASE model to act as a base station.

A list of models is in *Appendix A* of the *L1 GPS Firmware Reference Manual* and in our Price List available from the Sales side menu of our website at [www.novatel.com](http://www.novatel.com).

---

#### B.2.2.1 Normal Setup

See *Figure 5* on *Page 27* when following these instructions:

1. Connect the FlexPak-SSII COM1 serial port to a PC using the serial cable provided.
2. Connect the GPS antenna to the RF port (labelled ) on the FlexPak using coaxial cable.
3. Connect the power supply to the FlexPak-SSII power port (labelled ) using the automotive power cable. When power is applied, the LED should be red. See also *Section B.1.1, Status Indicators* on *Page 50*.
4. Launch the *StarView* software application, see *StarView Software Installation* on *Page 55*. Refer also to the *StarView User Manual*, see Reference [5] on *Page 13*.

**B.2.2.2 DGPS Setup with the FlexPak-SSII**

Set up the equipment as in *Figure 11* on *Page 54*, for differential messages. Differential operation requires that stations operate in pairs. Each pair consists of a base station and a rover station. For each receiver, the base and the rover, follow the set-up steps in *Section B.2.2.1* on *Page 53*. Then also connect a TTL communications device to each FlexPak-SSII using a serial connector on the FlexPak-SSII interface cable. For example this might be a radio modem, for sending or receiving differential GPS messages.

A differential network can also be established when there is more than one rover linked to a single base station. The base receiver must be initialized to fix its position to agree with latitude, longitude and height of the phase center of the base station GPS receiver antenna and the antenna offset position from the base.

The rover station must be tracking the same satellites as the base station in order for corrections to take effect. Only common satellite pseudoranges will use the differential corrections. When the rover is able to compute its positions based on pseudorange corrections from the base station, its position accuracies will approach that of the base station. The computed position solutions are that of the GPS receiving antenna phase center.

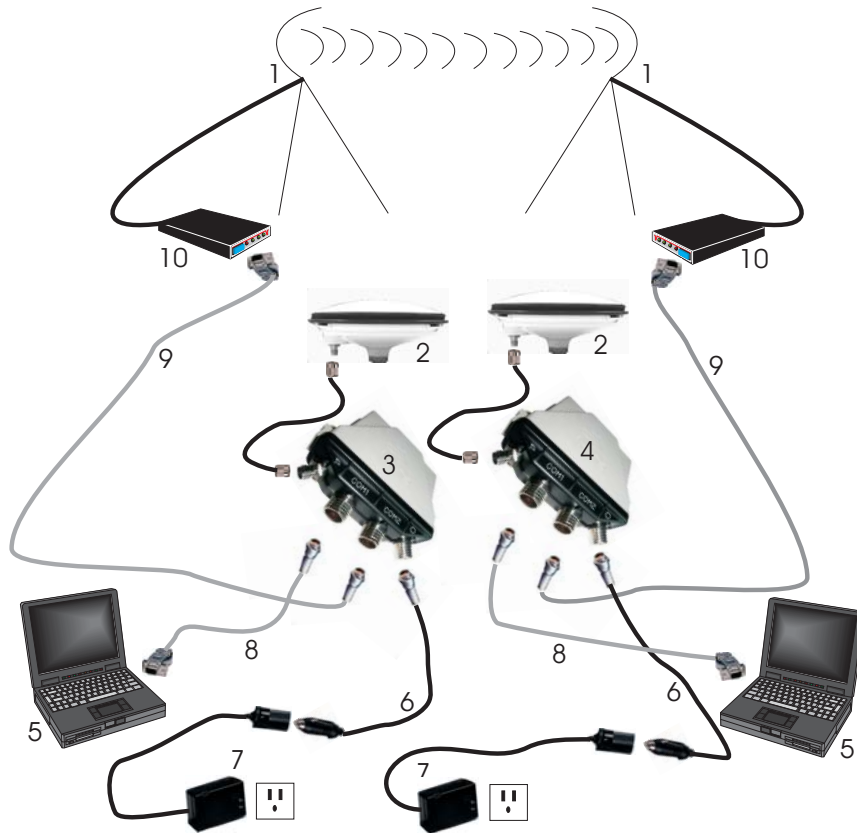

**Figure 11: Differential GPS Setup**

Reference	Description	Reference	Description
1	User-supplied radio data link	6	FlexPak power port to power cable
2	Antenna	7	12 V DC adaptor to 120 V AC power
3	FlexPak (base station)	8	PC to FlexPak COM1 port cable
4	FlexPak (rover station)	9	FlexPak COM2 port to modem cable
5	User-supplied PC	10	User-supplied modem

## B.3 StarView Software Installation

Once the receiver is connected to the PC, antenna, and power supply, install the *StarView* software. The *StarView CD* is supplied with the development kits, otherwise *StarView* is available on our website (see *below*).

From CD:

1. Start up the PC.
2. Insert the *StarView* CD in the CD-ROM drive of the computer.
3. Install the *StarView* software and follow the steps on the screen. If the setup utility is not automatically accessible when the CD is inserted, select *Run* from the *Start* menu and press the *Browse* button to locate Setup.exe on the CD drive.
4. Click on the *OK* button to install the *StarView* software and follow the steps on the screen.

From our website:

1. Start up the PC and launch your internet service program.
2. Go to our website at <http://www.novatel.com/Downloads/fwswupdates.html> and scroll down to the *Other Application Software* section.
3. Download the *StarView* setup program and save it in a temporary directory (for example, C:\temp).
4. Use the setup program to install the *StarView* software by following the steps on the screen.

---

☒ After installation, *StarView* also appears in the Windows Start menu at *Start | Program Files | NovAtel LI Software*.

---

The GPS antenna is an important part of the total system performance and its selection should be based on your application. The L1 GPS receivers include a Low Noise Amplifier (LNA) before the RF ASIC. This +20 dB LNA permits reasonable performances with a passive GPS antenna. But depending on the cable loss between the antenna element and the L1 GPS receiver, and position accuracy requirements, a +12 dB up to +36 dB active GPS antenna may be needed.

This appendix is divided into characteristics for high end active geodetic antennas and passive antennas.

We also offer the coaxial cables required between the GPS antenna and the SUPERSTAR II. You will also find in this section, different coaxial cables required in your GPS system. The end of this section includes detailed antenna drawings.

## C.1 Cable Selection

The interconnecting cable between the GPS antenna and the receiver is of prime importance for the proper performance of the system. Three parameters should be considered:

1. Loss
2. Isolation
3. Outer diameter

The bigger the outer diameter, the lower the loss. The loss increases with the length of the cable and decreases with extra isolation. If the highest accuracy possible is not required, receivers can accept a total cable loss of 3 dB. Depending on the cable type, this could represent a cable run from 2 m up to 10 m.

*Table 11 on Page 56* details the specifications of the RG-58 Low Loss Cable (RG-58/U LLDS80) used in the GPS antenna cable 217-601730-XXX. The RG-58/U LLDS80 is a custom-made low loss noise coaxial cable. It is a double-shielded cable similar to Belden Type 9310 but with the improvement of having 85% minimum coverage of the second shield versus the Belden at 55% coverage. The electrical characteristics are included in *Table 11*.

**Table 11: Coaxial Cable Specifications**

<b>Center Conductor</b>	#20 Bare Copper wire, Resistance - 33.1 ohms per Km
<b>Insulation</b>	Polyethylene
<b>Inner Shield</b>	Aluminium Foil - 100% coverage
<b>Outer Shield</b>	Tinned copper braid - 85% coverage, Resistance 45.9 ohms per Km
<b>Jacket</b>	Black PVC
<b>Nominal Impedance</b>	50 ohms
<b>Nominal Vel. of propagation</b>	66%
<b>Nominal Capacity</b>	101.7 pf per meter
<b>Attenuation</b>	@ 1000 MHz: 44.3 dB per 100 m (or 54 dB @ 1575 MHz)

*Table 12* shows the minimum and maximum cable length when using GPS antenna cable (drawing 217-601730-XXX) normally required between the receiver and the chassis case of your system. Please see *Page 60* for the cable drawing.



**Table 12: Antenna Gain Depending on Cable Length Required**

Cable PNs	ANTENNA GAIN	CABLE TYPE	MAX. LENGTH <sup>a</sup>	MIN. LENGTH
217-601730-XXX	0 dB (no LNA)	RG-58 Low Loss	3 meter (3 dB)	0 feet
217-601730-XXX	+12 dB	RG-58 Low Loss	20 meter (12 dB)	0 feet
217-601730-XXX	+36 dB	RG-58 Low Loss	65 meter (36 dB)	50 meter (28 dB)

a. A 1 dB loss for the coaxial cable is usually required between the RG-58 cable and the GPS Receiver MCX connector and it is included in attenuation number in parentheses. If the distance between the antenna and the GPS receiver needs to be longer than 65 m, you should select another type of coaxial cable with a lower loss per meter.

The +26 dB and +36 dB antenna can accept a supply voltage between 5 and 18 VDC. It is recommended to compute the drop in the coaxial cable so the active antenna will always see the minimum operating voltage of 4.5 Volt. *Table 13* lists the current taken by each of these antenna.

**Table 13: Typical Current Consumption Versus Antenna Gain**

Antenna Gain	Current Consumption
+12 dB	20 mA
+26 dB	35 mA
+36 dB	50 mA

## C.2 Geodetic Active Antenna

For DGPS applications where <1 m accuracy is required, it is strongly recommended you use an active geodetic GPS antenna if possible. In the event where the cable length between the receiver and the antenna is very short (less than one meter), a passive antenna could then be considered. *Table 14* lists the specifications for recommended passive antennas. Complete drawings are at the end of this appendix.

**Table 14: Recommended Geodetic Active Antennas**

Antenna Types	Part Number
Completely sealed round disk antenna with 1 inch thread, 5/8 inch adaptor, and built in ground plane	201-990147-606

The antenna gain should be selected depending on the cable loss between the antenna and the receiver. Prices and availability can be found in the latest Price List on our website.

### C.3 Active Antenna

Lower cost antennas for higher volume applications or for more cost sensitive applications are available.

L1 GPS receivers are manufactured by implementing a 20 dB LNA on board. For this reason, an active +12 dB antenna is more than adequate. An antenna with +26 dB to +36 dB may overdrive the RF input of the L1 GPS receiver if it is used with a short cable between the antenna and the receiver. *Table 15* lists the active antennas which could be used with any of the L1 GPS receivers.

**Table 15: Recommended Active Antennas**

Typical Applications	Part Numbers
AVL (This antenna is currently supplied with SUPERSTAR II development kits)	201-990146-716 (MCX connector & 6 meter cable) 201-990146-789 (BNC connector & 6 meter cable) 201-990148-152 (TNC connector & 6 meter cable)
Marine	201-990144-807 TNC Female Bulk head

☒ Prices and availability can be found in the latest Price List on our website at <http://www.novatel.com>.

### C.4 Passive Antenna

For DGPS applications where <1 m accuracy is required, it is strongly recommended to use an active geodetic GPS antenna if possible. In the event where the cable length between the receiver and the antenna is very short (less than one meter), a passive antenna could then be considered. *Table 16* on *Page 59* lists the specifications for recommended passive antennas.

Table 16: Passive Antenna Specifications (Patch Element)

Frequency	1575 MHz ±2 MHz
Polarization	Right Hand Circular
Radiation Coverage <sup>a</sup>	4.0 dBic 90 degrees -1.0 dBic 15 < θ < 90 -2.5 dBic 10 < θ < 15 -4.5 dBic 5 < θ < 10 -7.5 dBic 0 < θ < 5
Connector	TNC Female (most common although other connectors are also available)
Temperature	-55°C to +85°C
Environmental	DO-160C Standard

a. Elevation angle in degrees = θ

Lower cost antennas for higher volume applications or for more cost sensitive applications are available. L1 GPS receivers are manufactured by implementing a 20 dB LNA on board. For this reason, in many cost sensitive applications it may be necessary to select a passive antenna in conjunction with a low loss coaxial cable.

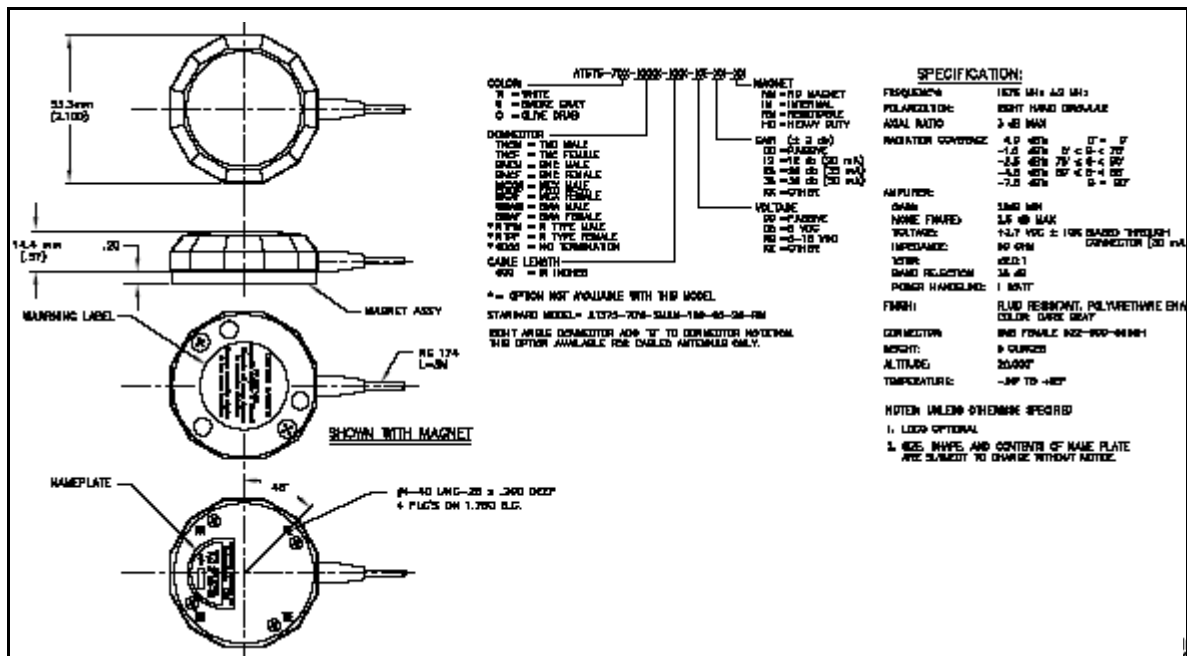

Figure 12: GPS Antenna 201-990146-716 (MCX, +12 dB)

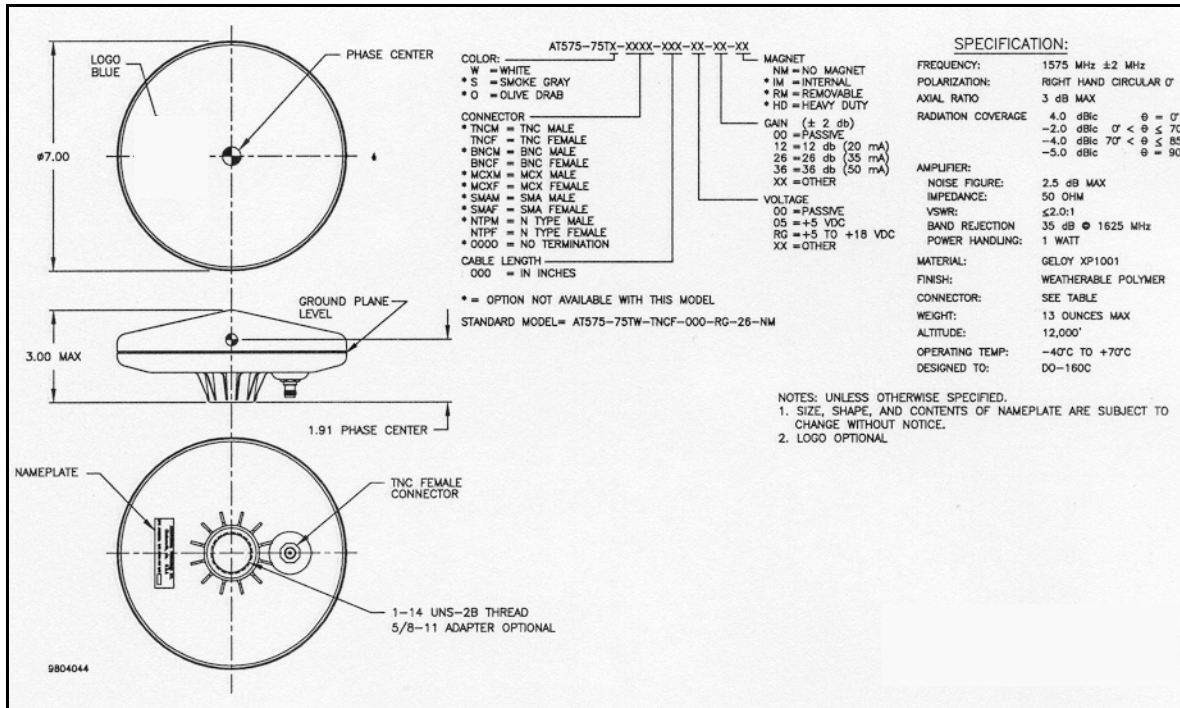

Figure 13: GPS Antenna 201-990147-606 (+26 dB)

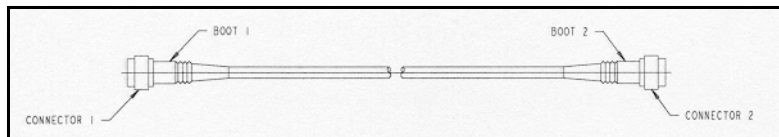

Figure 14: Coaxial Cable Assembly

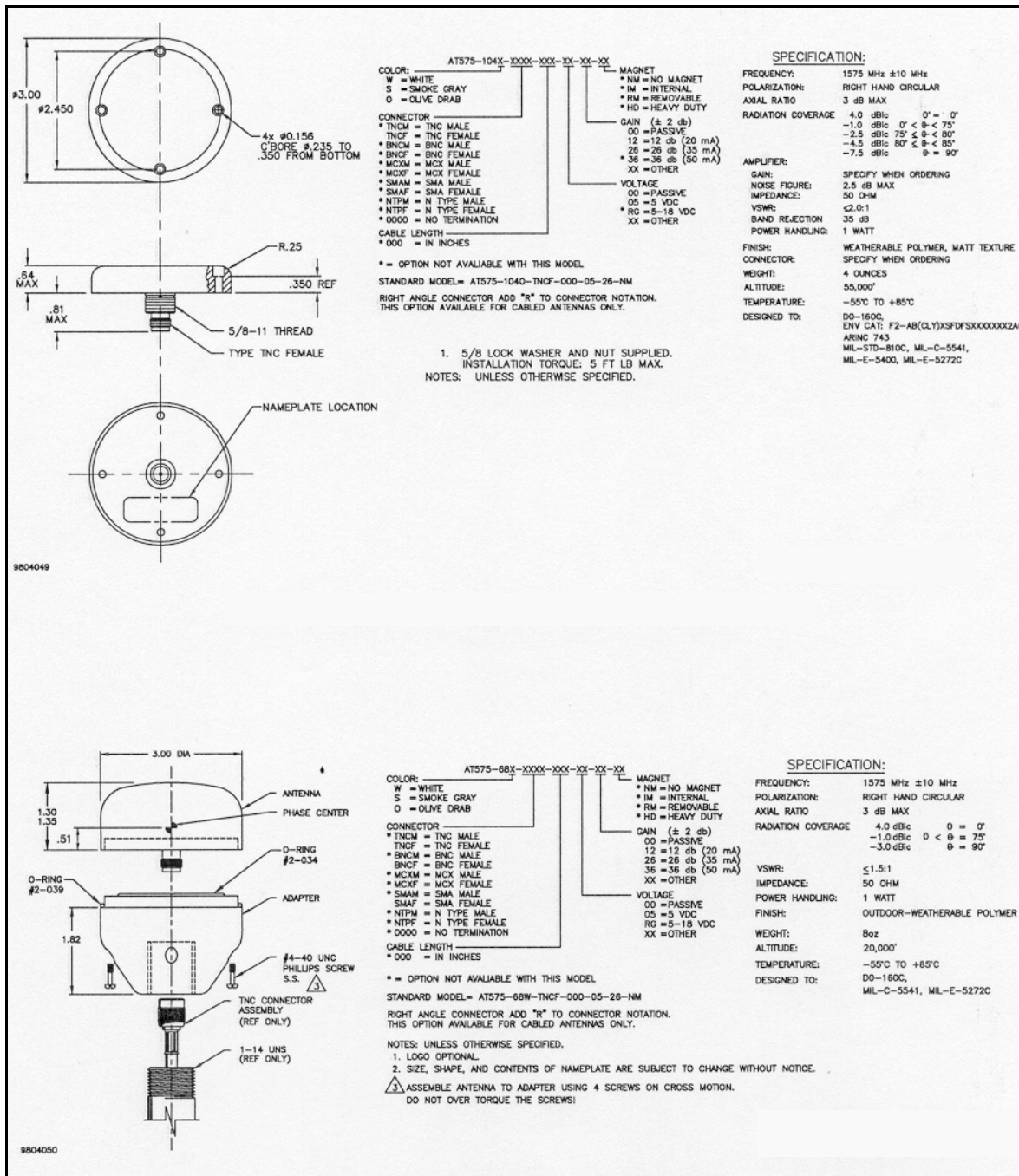

Figure 15: GPS Antenna 201-990147-432 (1575 MHz) and 201-990144-807 (Pre-Amplifier)

**RTCM STANDARDS REFERENCE**

For detailed specifications of RTCM, refer to RTCM SC104 Version 2.1 of "RTCM Recommended Standards For Differential NAVSTAR GPS Service", January 3, 1994

Radio Technical Commission For Maritime Services  
1800 Diagonal Road, Suite 600  
Alexandria, VA 22314-2480, USA

Phone: +1-703-684-4481

Fax: +1-703-836-4229

E-Mail: [information@rtcm.org](mailto:information@rtcm.org)

Website: <http://www.rtcmm.org/>

**NMEA REFERENCE**

National Marine Electronics Association, NMEA 0183 Standard for Interfacing Marine Electronic Devices, Version 2.00, January 1, 1992

NMEA Executive Director  
Seven Riggs Avenue  
Severna Park, MD 21146

Phone: 410-975-9425

Fax: 410-975-9450

E-Mail: [info@nmea.org](mailto:info@nmea.org)

Website: <http://www.nmea.org>

**GEODETTIC SURVEY OF CANADA**

Natural Resources Canada  
Geodetic Survey Division  
Geomatics Canada  
615 Booth Street, Room 440  
Ottawa, Ontario, Canada, K1A 0E9

Phone: (613) 995-4410

Fax: (613)995-3215

E-Mail: [information@geod.nrcan.gc.ca](mailto:information@geod.nrcan.gc.ca)

Website: <http://www.geod.emr.ca>

**U.S. NATIONAL GEODETTIC SURVEY**

NGS Information Services  
1315 East-West Highway  
Station 9244  
Silver Springs, MD 20910-3282

Phone: (301)713-2692

Fax: (301)713-4172

E-Mail: [info\\_center@ngs.noaa.gov](mailto:info_center@ngs.noaa.gov)

Website: <http://www.ngs.noaa.gov>

**NAVSTAR GPS**

NAVSTAR GPS  
United States Naval Observatory (USNO)  
3450 Massachusetts Avenue, NW  
Washington, DC 20392-5420

Phone: (202) 762-1467

Website: <http://tycho.usno.navy.mil/gps.html>

**SOCIETY OF AUTOMOTIVE ENGINEERING**

SAE World Headquarters  
400 Commonwealth Drive  
Warrendale, PA 15096-0001 USA

Phone: (724)776-4841

Fax: (724)776-0790

E-Mail: [CustomerService@sae.org](mailto:CustomerService@sae.org)

Website: <http://www.sae.org/servlets/index>

---

☒ Website addresses may be subject to change however they are accurate at the time of publication.

---

## **E.1 Time-To-First-Fix (TTFF)**

The receiver enters Navigation mode, see *Operational States on Page 31*, and provides valid outputs in less than 50 seconds after completion of the self-test and the following initialization criteria have been met:

1. Valid time ( $\pm 10$  minutes) and position data ( $\pm 100$  km) from actual position
2. Valid almanac data (less than a year old)
3. At least 4 satellites greater than  $5^\circ$  elevation above the horizon
4. HDOP  $< 6$

The time allowed for self-test and device initialization is less than 5 seconds.

In the case where the following additional conditions are met, the TTFF is reduced to less than 30 seconds:

- Unit has not been off for more than a week before nominal power is re-applied
- Last navigation fix occurred within the last 2 hours
- Valid ephemeris data (less than 4 hours old) for at least 5 satellites

With no initialization, the time from power application to valid navigation output is typically less than 3 minutes.

## **E.2 Re-Acquisition**

Re-acquisition is the resumption of tracking and measurement processing.

There is no disruption of navigation data output when a satellite signal is lost unless there is a power interruption for a period of less than or equal to 200 ms. Also, the receiver re-acquires the satellite signal within 0.3 seconds after satellite visibility has been restored.

When a satellite signal is lost due to signal masking, the signal is typically re-acquired within 2-3 seconds after the satellite signal meets the minimum input levels. The vehicle dynamics during the masking period are assumed to be less than or equal to 0.5 g acceleration and 100 m/s velocity.

When total signal masking occurs, navigation resumes within 3-5 seconds of a Navigation mode criteria being met.

The receiver is capable of acquiring satellite signals with a minimum input carrier-to-noise density ratio (C/N0) to the correlator of 34 dB-Hz. Once a signal has been acquired, the receiver is capable of tracking satellite signals with a minimum input carrier-to-noise density ratio (C/N0) to the correlator of 31 dB-Hz.

The software update utility is specially designed to provide an easy way to update your SUPERSTAR II software and model. The software package includes the following items:

- An update utility, usually called update.exe (may be named otherwise)
- An activation key
- An application note containing the instructions as they are in this appendix

## F.1 System Requirements

Before you use the update utility, make sure your computer is IBM PC-compatible with the following minimum system requirements:

- Intel-compatible 486DX-66 MHz CPU or higher
- One standard serial port
- Windows 95 operating system or higher

## F.2 Utility Installation

Follow the steps below to install the Update utility:

1. Create a folder on the PC and name it "Update" for the Update utility installation. The folder name is not critical, but avoid names that are over 8 characters long.
2. Copy the Update utility executable file (update.exe for this example) into the newly created folder.
3. Select *Run* from the *Start* menu and press the *Browse* button to locate update.exe in the Update folder. Select update.exe, press the *Open* button and then *OK*.

Alternatively, you can create a shortcut to the update.exe program on your desktop.

## F.3 Registration Key

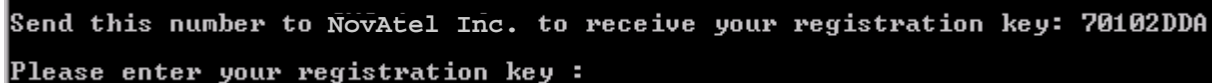

```
-----  
Send this number to NovAtel Inc. to receive your registration key: 70102DDA  
Please enter your registration key :
```

**Figure 16: Update Registration Window in DOS**

Contact NovAtel Inc. with the number that appears on your screen to obtain your registration key, see *Figure 16* above. Contact information can be found on *Page 9*. Follow the steps below to enter the registration key:

1. Copy and paste the registration key from a text file or the Customer Service e-mail. Right-click on the left corner of the DOS window, and select *Edit / Paste*, see *Figure 17* on *Page 65*. The registration key can also be entered manually.
2. Press <Enter>.

---

☒ The registration key contains your host computer information. Only the computer that originally generated the ID number that you sent to NovAtel, is able to run the update.exe program. If you have multiple updates or upgrades, you must do them all from this one computer.

---



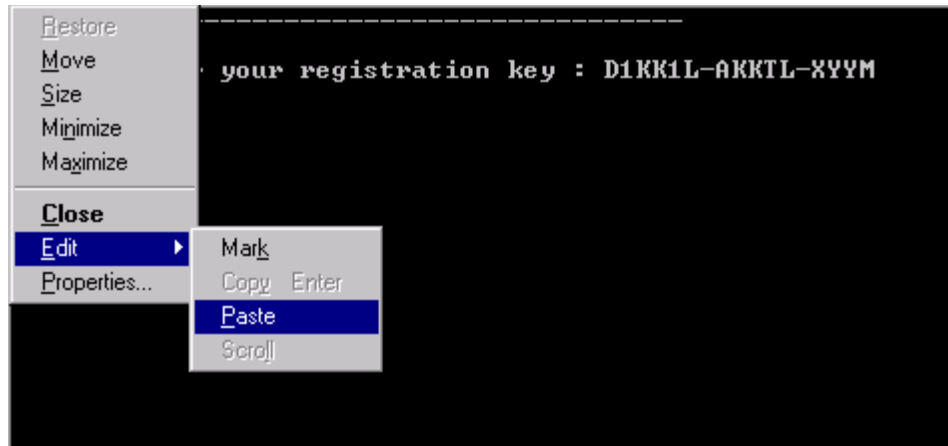

Figure 17: Paste the Registration Key into the DOS Window

## F.4 Registration Key Accepted

A message confirms the Update software utility activation once the key has been entered, see *Figure 18* below. Press any key, for example <Enter>, to exit.

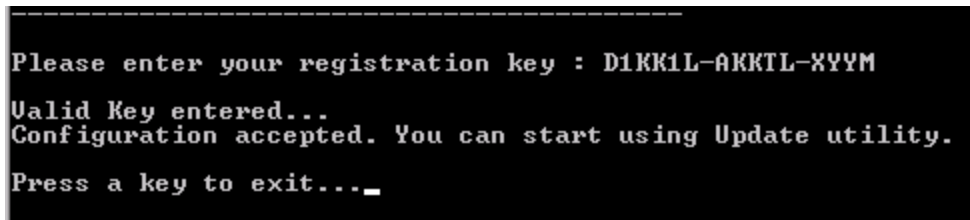

Figure 18: Configuration Accepted

## F.5 Starting Software and Options Update

Once activated, the Update utility works until the date or session counter expires. Simply follow the instructions on the screen. The Update utility prompts you to remove or apply power to the GPS receiver. The sessions counter decrements every time a programming session is successfully executed. An example is shown in *Figure 19* below.

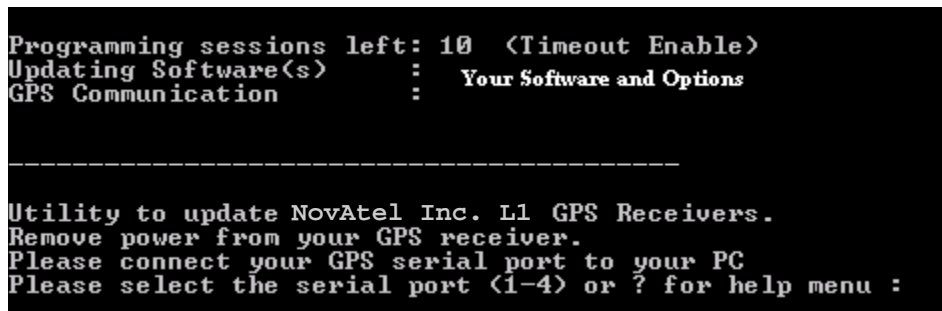

Figure 19: Update Utility Activation

### F.5.1 Programming Success

The Update utility confirms programming success at the end of the programming session, see *Figure 20* below. At this point, remove power from your GPS receiver.

```
-----  
Checking GPS receiver. Please wait...  
.....  
For a final check please remove power from your GPS receiver.  
Then press Enter.  
  
Please apply power to your GPS receiver  
Configuration verification  
.....  
-----  
Your receiver has been updated successfully.  
Thank you.  
Press a key to exit..._
```

Figure 20: End of Programming Session

The Global Positioning System (GPS) is a satellite navigation system capable of providing a highly accurate, continuous global navigation service independent of other positioning aids. GPS provides 24-hour, all-weather, worldwide coverage with position, velocity and timing information.

The system uses the NAVSTAR (NAVigation Satellite Timing And Ranging) satellites which consists of 24 operational satellites to provide a GPS receiver with at least six satellites in view at all times. A minimum of four satellites in view are needed to allow the receiver to compute its current latitude, longitude, altitude with reference to mean sea level and the GPS system time.

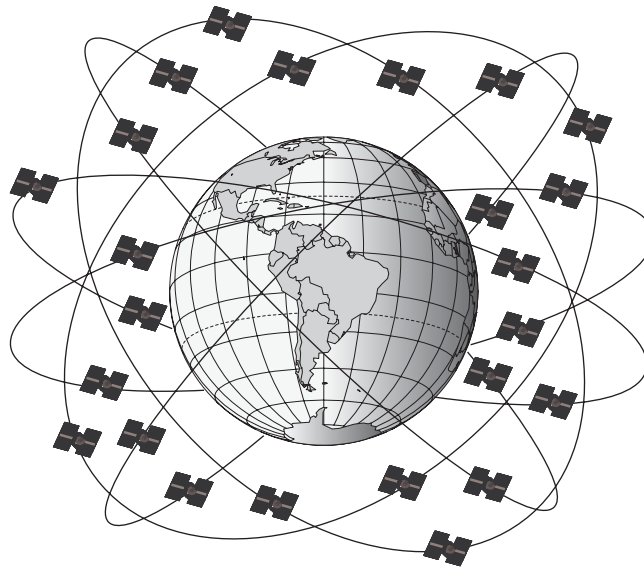

**Figure 21: NAVSTAR Satellite Orbit Arrangement**

## **G.1 GPS System Design**

The GPS system design consists of three parts:

- The Space segment
- The Control segment
- The User segment

All these parts operate together to provide accurate three dimensional positioning, timing and velocity data to users worldwide.

### **G.1.1 The Space Segment**

The space segment is composed of the NAVSTAR GPS satellites. The constellation of the system consists of 24 satellites in six 55° orbital planes, with four satellites in each plane. The orbit period of each satellite is approximately 12 hours at an altitude of 20 183 kilometers. This provides a GPS receiver with at least six satellites in view from any point on earth, at any particular time.

The GPS satellite signal identifies the satellite and provides the positioning, timing, ranging data, satellite status and the corrected ephemerides (orbit parameters) of the satellite to the users. The satellites can be identified either by the Space Vehicle Number (SVN) or the Pseudorandom Code Number (PRN). The PRN is used by the NovAtel receiver.

The GPS satellites transmit on two L-band frequencies; one centered at 1575.42 MHz (L1) and the other at 1227.60 MHz (L2). The L1 carrier is modulated by the C/A code (Coarse/Acquisition) and the P code

(Precision) which is encrypted for military and other authorized users. The L2 carrier is modulated only with the P code.

### **G.1.2 The Control Segment**

The control segment consists of a master control station, five base stations and three data up-loading stations in locations all around the globe.

The base stations track and monitor the satellites via their broadcast signals. The broadcast signals contain the ephemeris data of the satellites, the ranging signals, the clock data and the almanac data. These signals are passed to the master control station where the ephemerides are re-computed. The resulting ephemerides corrections and timing corrections are transmitted back to the satellites through the data up-loading stations.

### **G.1.3 The User Segment**

The user segment, such as the NovAtel receiver, consists of equipment which tracks and receives the satellite signals. The user equipment must be capable of simultaneously processing the signals from a minimum of four satellites to obtain accurate position, velocity and timing measurements.

## **G.2 Height Relationships**

### ***What is a geoid?***

An equipotential surface is any surface where gravity is constant. This surface best represents mean sea-level and not only covers the water but is projected throughout the continents. In North America this surface is most commonly used at its zero value, i.e. all heights are referenced to this surface.

### ***What is an ellipsoid?***

An ellipsoid, also known as a spheroid, is a mathematical surface which is sometimes used to represent the earth. Whenever you see latitudes and longitudes describing the location, this coordinate is being referenced to a specific ellipsoid. GPS positions are referred to an ellipsoid known as WGS84 (World Geodetic System of 1984).

### ***What is the relationship between a geoid and an ellipsoid?***

The relationship between a geoid and an ellipsoid is shown in “*Illustration of Receiver Height Measurements*” on Page 69.

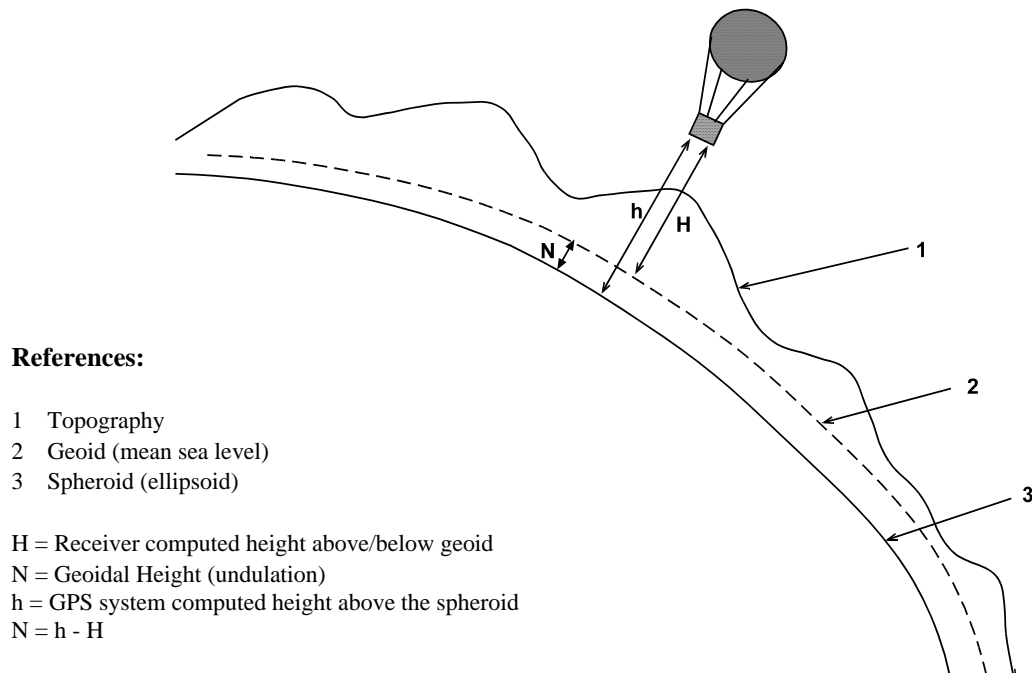

**Figure 22: Illustration of Receiver Height Measurements**

From the above diagram, and the formula  $h = H + N$ , to convert heights between the ellipsoid and geoid we require the geoid-ellipsoid separation value. This value is not easy to determine. A world-wide model is generally used to provide these values. NovAtel GPS receivers store this value internally. This model can also be augmented with local height and gravity information. A more precise geoid model is available from government survey agencies e.g. U.S. National Geodetic Survey or Geodetic Survey of Canada (see *Appendix D, Standards/References on Page 62*).

***Why is this important for GPS users?***

The above formula is critical for GPS users as they typically obtain ellipsoid heights and need to convert these into mean sea-level heights. Once this conversion is complete, users can relate their GPS derived heights to more “usable” mean sea-level heights.

### G.3 GPS Positioning

GPS positioning can be categorized as follows:

1. single-point or relative
2. static or kinematic
3. real-time or post-mission data processing

A distinction should be made between *accuracy* and *precision*. *Accuracy* refers to how close an estimate or measurement is to the true but unknown value; *precision* refers to how close an estimate is to the mean (average) estimate. “*Accuracy versus Precision*” on *Page 70* illustrates various relationships between these two parameters: the true value is “located” at the intersection of the cross-hairs, the centre of the shaded area is the “location” of the mean estimate, and the radius of the shaded area is a measure of the uncertainty contained in the estimate.

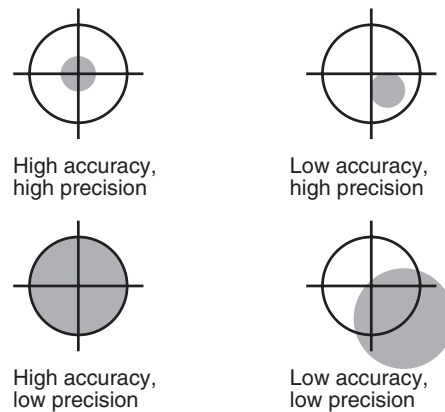

**Figure 23: Accuracy versus Precision<sup>1</sup>**

### G.3.1 Single-Point vs. Relative Positioning

In *single-point* positioning, coordinates of a GPS receiver at an unknown location are sought with respect to the earth's reference frame by using the known positions of GPS satellites being tracked. The position solution generated by the receiver is initially developed in earth-centered coordinates which can subsequently be converted to any other coordinate system. With as few as four GPS satellites in view, the absolute position of the receiver in three-dimensional space can be determined. Only one receiver is needed.

In *relative* positioning, also known as *differential* positioning, the coordinates of a GPS receiver at an unknown point (the “rover” station) are sought with respect to a GPS receiver at a known point (the “base” station). The concept is illustrated in *Figure 24, Example of Differential Positioning on Page 71*. The relative-position accuracy of two receivers locked on the same satellites and not far removed from each other - up to tens of kilometers - is extremely high. The largest error contributors in single-point positioning are those associated with atmospheric-induced effects. These errors, however, are highly correlated for adjacent receivers and hence cancel out in relative measurements. Since the position of the base station can be determined to a high degree of accuracy using conventional surveying techniques, any differences between its known position and the position computed using GPS techniques can be attributed to various components of error as well as the receiver's clock bias. Once the estimated clock bias is removed, the remaining error on each pseudorange can be determined. The base station sends information about each satellite to the rover station, which in turn can determine its position much more exactly than would be possible otherwise.

The advantage of relative positioning is that much greater precision (<1 m, depending on the method and environment) can be achieved than by single-point positioning. In order for the observations of the base station to be integrated with those of the rover station, relative positioning requires either a data link between the two stations (if the positioning is to be achieved in real-time) or else post-processing of the data collected by the rover station. At least four GPS satellites in view are still required. The absolute accuracy of the rover station's computed position will depend on the accuracy of the base station's position.

<sup>1</sup>.Environment Canada, 1993, Guideline for the Application of GPS Positioning, p. 22.  
© Minister of Supply and Services Canada

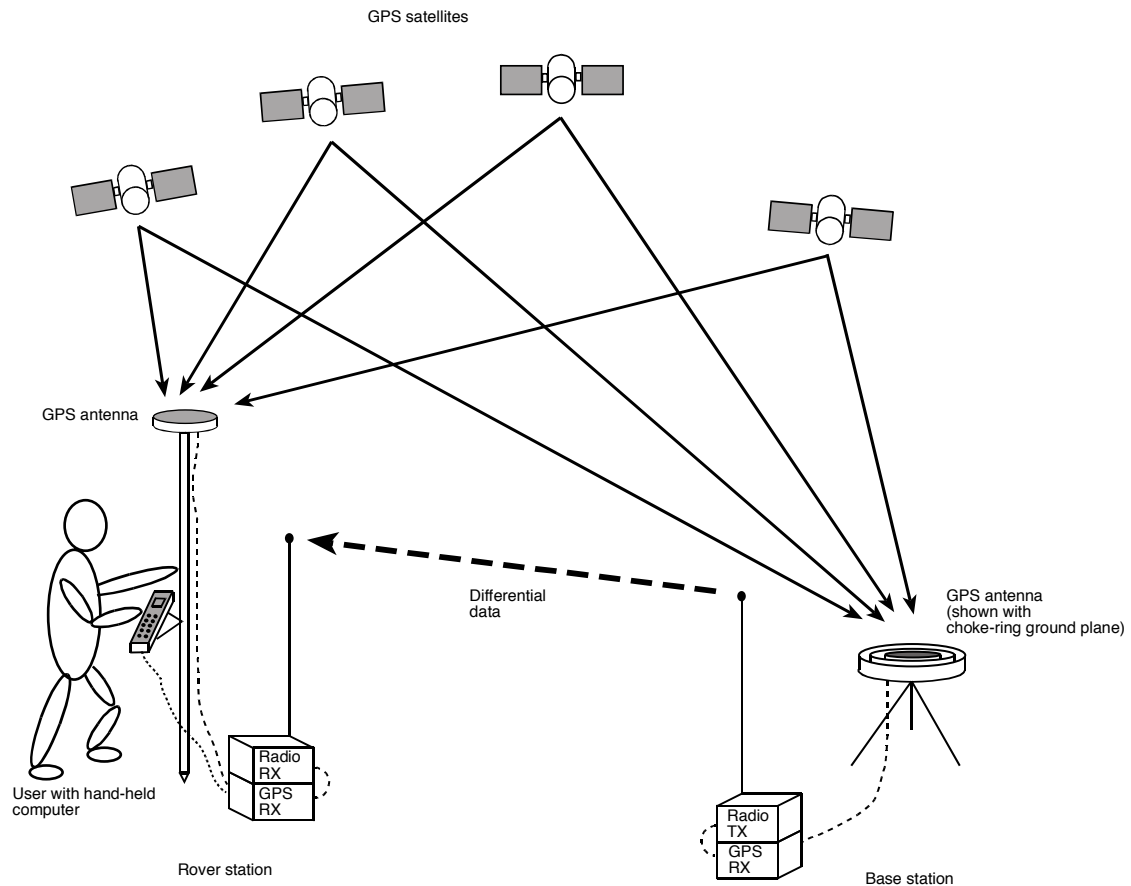

**Figure 24: Example of Differential Positioning**

### G.3.2 Static vs. Kinematic Positioning

*Static* and *kinematic* positioning refer to whether a GPS receiver is stationary or in motion while collecting GPS data.

### G.3.3 Real-time vs. Post-mission Data Processing

*Real-time* or *post-mission* data processing refer to whether the GPS data collected by the receiver is processed as it is received or after the entire data-collection session is complete.

## G.4 Multipath

Multipath signal reception is one of the most plagues problems that detracts from the accuracy potential of GPS pseudorange differential positioning systems. This section will provide a brief look at the problems of multipath reception and some solutions.

Multipath occurs when an RF signal arrives at the receiving antenna from more than one propagation route (multiple propagation paths), see *Figure 25* on *Page 72*.

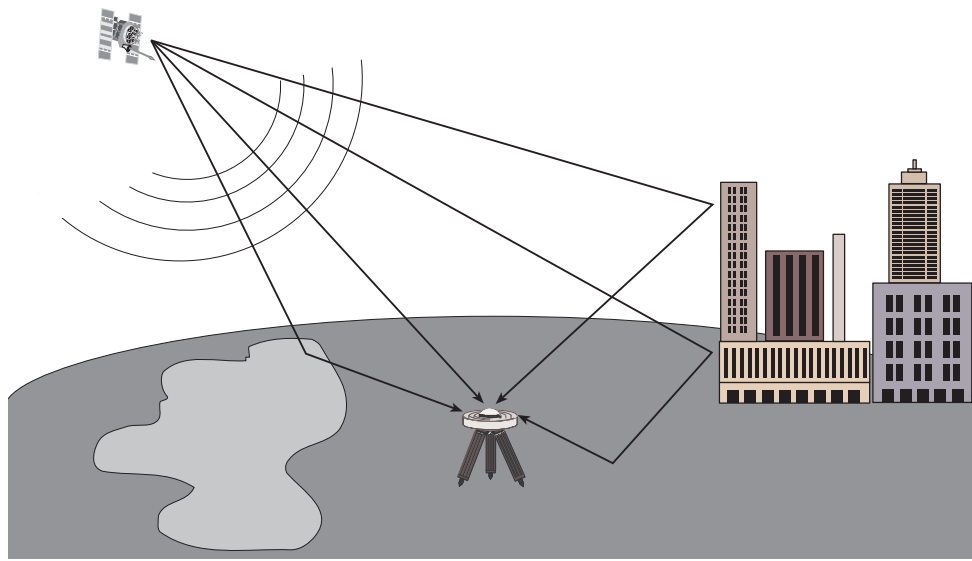

**Figure 25: Illustration of GPS Signal Multipath**

#### **G.4.1 Why Does Multipath Occur?**

When the GPS signal is emitted from the satellite antenna, the RF signal propagates away from the antenna in many directions. Because the RF signal is emitted in many directions simultaneously and is traveling different paths, these signals encounter various and differing natural and man-made objects along the various propagation routes. Whenever a change in medium is encountered, the signal is either absorbed, attenuated, refracted, or reflected.

Refraction and reflection cause the signals to change direction of propagation. This change in path directions often results in a convergence of the direct path signal with one or more of the reflected signals. When the receiving antenna is the point of convergence for these multipath signals, the consequences are generally not favorable.

Whenever the signal is refracted, some signal polarity shifting takes place. When full reflection occurs, full polarity reversal results in the propagating wave. The consequences of signal polarity shifting and reversal at the receiving antenna vary from minor to significant. As well, refracted and reflected signals generally sustain some degree of signal amplitude attenuation.

It is generally understood that, in multipath conditions, both the direct and reflected signals are present at the antenna and the multipath signals are lower in amplitude than the direct signal. However, in some situations, the direct signal may be obstructed or greatly attenuated to a level well below that of the received multipath signal. Obstruction of direct path signals is very common in city environments where many tall buildings block the line of sight to the satellites. As buildings generally contain an abundance of metallic materials, GPS signal reflections are abundant (if not overwhelming) in these settings. Obstructions of direct path signals can occur in wilderness settings as well. If the GPS receiver is in a valley with nearby hills, mountains and heavy vegetation, signal obstruction and attenuation are also very common.

#### **G.4.2 Consequences of Multipath Reception**

Because GPS is a radio ranging and positioning system, it is imperative that ground station signal reception from each satellite be of direct line of sight. This is critical to the accuracy of the ranging measurements. Obviously, anything other than direct line of sight reception will skew and bias the range measurements and thus the positioning triangulation (or more correctly, trilateration). Unfortunately, multipath is almost always



present to some degree, due to real world conditions.

When a GPS multipath signal converges at the GPS antenna, there are two primary problems that occur:

1. a multiple signal with amplitude and phase shifting, and
2. a multiple signal with differing ranges.

When a direct signal and multipath signal are intercepted by the GPS antenna, the two signals will sum according to the phase and amplitude of each. This summation of signals causes the composite to vary greatly in amplitude, depending on the degree of phase shift between the direct signal versus the multipath signal. If the multipath signal lags the direct path signal by less than 90° the composite signal will increase in amplitude (relative to the direct signal, depending on the degree of phase shift between 0° and 90°). As well, if the multipath signal lags the direct path signal by greater than 90° but less than 270° the composite signal will decrease in amplitude. Depending on the relative amplitude of the multipath signal (or signals), the composite signal being processed by the receiver correlator may experience substantial amplitude variations. A worst case scenario is when the multipath signal experiences a lag of 180° and is near the same strength as the direct path signal – this will cause the multipath signal to almost completely cancel out the direct path signal, resulting in loss of satellite phase lock or even code lock.

Because a multipath signal travels a greater distance to arrive at the GPS antenna, the two C/A code correlations are, by varying degrees, displaced in time, which in turn causes distortion in the correlation peak and thus ambiguity errors in the pseudorange (and carrier phase, if applicable) measurements.

As mentioned in previous paragraphs, it is possible that the received multipath signal has greater amplitude than the direct path signal. In such a situation the multipath signal becomes the dominant signal and receiver pseudorange errors become significant due to dominant multipath biases and may exceed 150 meters. For single point pseudorange positioning, these occasional levels of error may be tolerable, as the accuracy expectations are at the 5 meter CEP level (using standard correlator). However, for pseudorange single differencing DGPS users, the accuracy expectations are at the 1 meter CEP level (with no multipath). Obviously, multipath biases now become a major consideration in trying to achieve the best possible pseudorange measurements and position accuracy.

If a differential base station is subject to significant multipath conditions, this in turn will bias the range corrections transmitted to the differential rover receiver. And in turn, if the rover receiver also experiences a high level of multipath, the rover receiver position solutions will be significantly biased by multipath from both stations. Thus, when the best possible position solutions are required, multipath is certainly a phenomenon that requires serious consideration.

### **G.4.3 Hardware Solutions For Multipath Reduction**

A few options exist by which GPS users may reduce the level of multipath reception. Among these include: antenna site selection, special antenna design, and ground plane options.

#### **G.4.3.1 Antenna Site Selection**

Multipath reception is basically a condition caused by environmental circumstances. Some of these conditions you may have a choice about and some you may not.

Many GPS reception problems can be reduced, to some degree, by careful antenna site selection. Of primary importance is to place the antenna so that unobstructed line-of-sight reception is possible from horizon to horizon and at all bearings and elevation angles from the antenna. This is, of course, the ideal situation, which may not be possible under actual operating conditions.

Try to place the antenna as far as possible from obvious reflective objects, especially reflective objects that are above the antenna's radiation pattern horizon. Close-in reflections will be stronger, and typically have a shorter propagation delay allowing for auto correlation of signals with a propagation delay of less than one C/A code chip (300 meters).

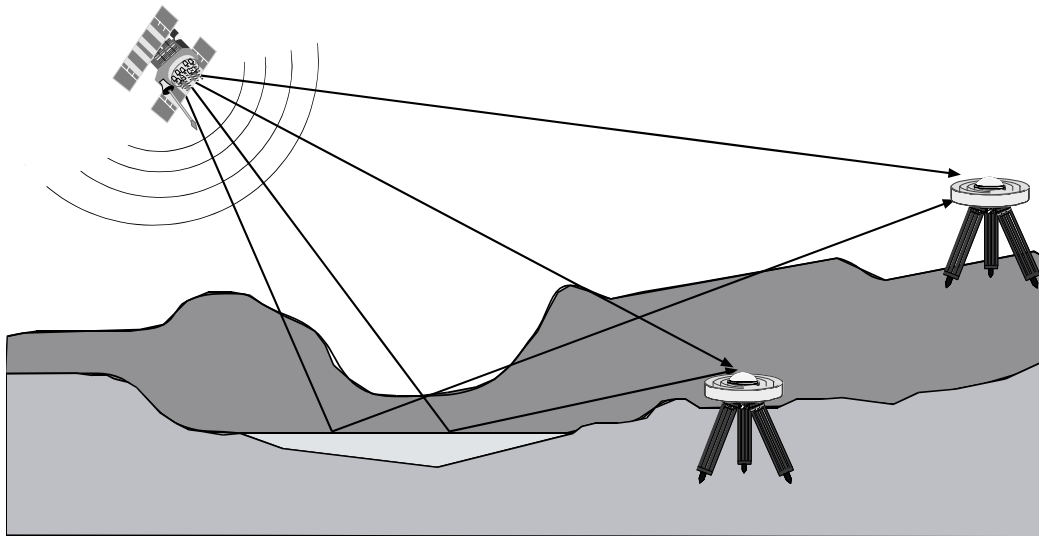

**Figure 26: GPS Signal Multipath vs. Increased Antenna Height**

When the antenna is in an environment with obstructions and reflective surfaces in the vicinity, it is advantageous to mount the antenna as high as possible to reduce the obstructions, as well as reception from reflective surfaces, as much as possible. See *Figure 26* above for an example.

Water bodies are extremely good reflectors of GPS signals. Because of the short wavelengths at GPS frequencies, even small ponds and water puddles can be a strong source of multipath reception, especially for low angle satellites. Thus, it can be concluded that water bodies such as lakes and oceans are among the most troublesome multipath environments for low angle signal reception. Obviously, water body reflections are a constant problem for ocean going vessels.

#### **G.4.3.2 Antenna Designs**

Low angle reflections, such as from water bodies, can be reduced by careful selection of the antenna design. For example, flat plate microstrip patch antennas have relatively poor reception properties at low elevation angles near their radiation pattern horizon.

Quadrifilar helix antennas and other similar vertically high profile antennas tend to have high radiation gain patterns at the horizon. These antennas, in general, are more susceptible to the problems resulting from low angle multipath reception. So, for marine vessels, this type of antenna encourages multipath reception. However, the advantages of good low angle reception also means that satellites can be acquired more easily while rising in the horizon. As well, vessels subject to pitch and roll conditions will experience fewer occurrences of satellite loss of lock.

Examples of the above antennas may be seen in *Figure 27* on *Page 75*.

A good antenna design will also incorporate some form of left hand circular polarization (LHCP) rejection. Multipath signals change polarization during the refraction and reflection process. This means that generally, multipath signals may be LHCP oriented. This property can be used to advantage by GPS antenna designers. If a GPS antenna is well designed for RHCP polarization, then LHCP multipath signals will automatically be attenuated somewhat during the induction into the antenna. To further enhance performance, antennas can be designed to increase the rejection of LHCP signals.

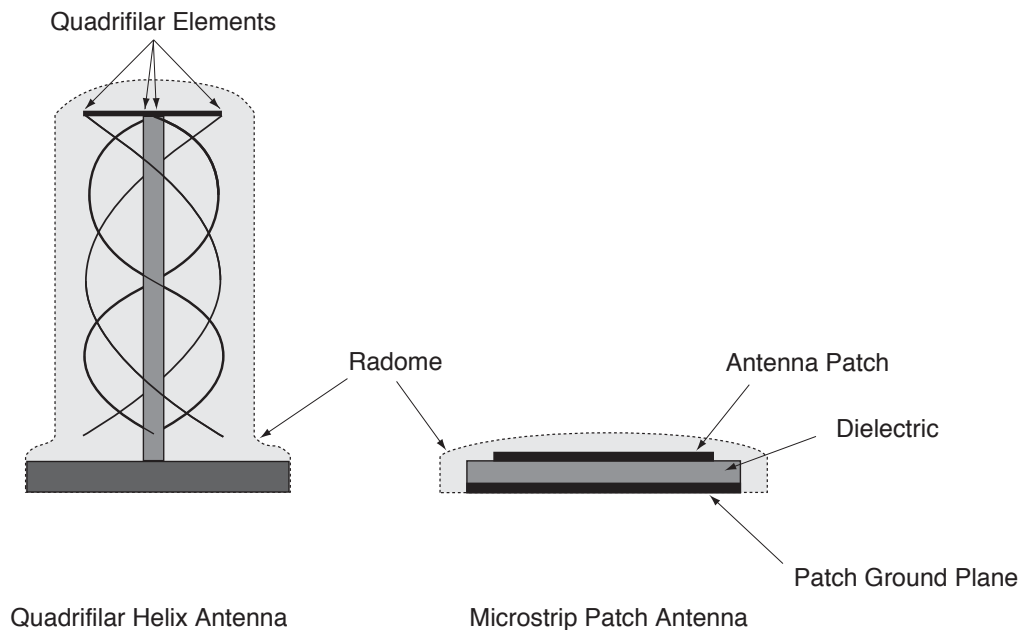

**Figure 27: Illustration of Quadrifilar vs. Microstrip Patch Antennas**

#### G.4.3.3 Antenna Ground Planes

Nearby objects can influence the radiation pattern of an antenna. Thus, one of the roles of the antenna ground plane is to create a stabilizing artificial environment on which the antenna rests and which becomes a part of the antenna structure and its resultant radiation pattern.

A small ground plane (relative to one wavelength at the operating frequency) may have minimal stabilizing effect, whereas a large ground plane (multiple wavelengths in size) will have a highly stabilizing effect.

Large ground planes also exhibit a shielding effect against RF signal reflections originating below the antenna's radiation pattern horizon. This can be a very effective low angle shield when the antenna is elevated on a hill or other structure above other reflecting surfaces such as vehicles, railway tracks, soil with high moisture content, water bodies, etc.

One of the drawbacks of a "flat plate" ground plane is that it gives a "hard boundary condition", i.e. allowing electromagnetic waves to propagate along the ground plane and diffract strongly from its edge. The "soft boundary" condition, on the other hand, will prevent the wave from propagating along the surface of the ground plane and thereby reducing the edge diffraction effects. As a result the antenna will exhibit a completely different radiation pattern. The "soft boundary" condition is typically achieved by a quarter wavelength deep, transversely corrugated ground plane surface (denoted as "choke ring ground plane"). When the depth of the corrugation (choke rings) is equal to a quarter wavelength, the surface wave vanishes, and the surface impedance becomes infinite and hence provides the "soft boundary" condition for the electromagnetic field. This results in modifications to the antenna radiation pattern that is characterized by low back lobe levels, no ripples in the main lobe, sharper amplitude, roll-off near the horizon and better phase center stability (there are smaller variations in 2 axes). This is what makes NovAtel's GPS antennas so successful when used with the NovAtel GPS Antenna choke ring ground plane.

**ASCII** - A 7 bit wide serial code describing numbers, upper and lower case alpha characters, special and non-printing characters.

**Almanac** - a set of orbit parameters that allows calculation of approximate GPS satellite positions and velocities. The almanac is used by a GPS receiver to determine satellite visibility and as an aid during acquisition of GPS satellite signals.

**Attenuation** - reduction of signal strength.

**Carrier** - the steady transmitted RF signal whose amplitude, frequency, or phase may be modulated to carry information.

**Checksum** - by NMEA standard, a validity check performed on the data contained in the sentences, calculated by the talker, appended to the message, then recalculated by the listener for comparison to determine if the message was received correctly. Required for some sentences, optional for all others.

**Circular Error Probable (CEP)** - the radius of a circle, centered at the user's true location, that contains 50 percent of the individual position measurements made using a particular navigation system.

**Coarse Acquisition (C/A) Code** - a spread spectrum direct sequence code that is used primarily by commercial GPS receivers to determine the range to the transmitting GPS satellite. Uses a chip rate of 1.023 MHz.

**Control segment** - the Master Control Station and the globally dispersed Monitor Stations used to manage the GPS satellites, determine their precise orbital parameters, and synchronize their clocks.

**Differential GPS (DGPS)** - a technique to improve GPS accuracy that uses pseudorange errors measured at a known location to improve the measurements made by other GPS receivers within the general geographic area.

**Dilution of Precision (DOP)** - A numerical value expressing the confidence factor of the position solution based on current satellite geometry. The lower the value, the greater the confidence in the solution. DOP can be expressed in the following forms:

GDOP	all parameters are uncertain (latitude, longitude, height, clock offset)
PDOP	3D parameters are uncertain (latitude, longitude, height)
HTDOP	2D parameters and time are uncertain (latitude, longitude, time)
HDOP	2D parameters are uncertain (latitude, longitude)
VDOP	height is uncertain
TDOP	clock offset is uncertain

**Earth-Centered-Earth-Fixed (ECEF)** - a right-hand Cartesian coordinate system with its origin located at the center of the Earth used by GPS to describe three-dimensional location. ECEF coordinates are centered on the WGS-84 reference ellipsoid, have the "Z" axis aligned with the Earth's spin axis, the "X" axis through the intersection of the Prime Meridian and the Equator and the "Y" axis is rotated 90 degrees East of the "X" axis about the "Z" axis.

**Ephemeris** - a set of satellite orbit parameters that is used by a GPS receiver to calculate precise GPS satellite positions and velocities. The ephemeris is used in the determination of the navigation solution and is updated periodically by the satellite to maintain the accuracy of GPS receivers.

**Field** - a character or string of characters immediately preceded by a field delimiter.

**Figure of Merit** - The receiver provides an estimated accuracy level. The accuracy level estimate is provided in the horizontal and vertical Figure of Merit (FOM). The FOM reflects a 95% confidence level for the position solution accuracy estimate. The FOM accounts for all major sources of errors in the pseudoranges of the satellites used in the position solution. The error sources which are included are ionospheric and tropospheric errors, satellite position errors based on transmitted user range error, and thermal noise.

**Fixed field** - a field in which the number of characters is fixed. For data fields, such fields are shown in the sentence definitions with no decimal point. Other fields which fall into this category are the address field and the checksum field (if present).

**GDOP** - Geometric Dilution of Precision - A numerical value expressing the confidence factor of the position solution based on current satellite geometry. Assumes that 3D position (latitude, longitude, height) and receiver clock offset (time) are variables in the solution. The lower the GDOP value, the greater the confidence in the solution.

**Geodetic datum** - the reference ellipsoid surface that defines the coordinate system.

**Geoid** - the figure of the earth considered as a sea level surface extended continuously through the continents. The actual geoid is an equipotential surface coincident with mean sea level to which at every point the plumb line (direction in which gravity acts) is perpendicular.

**Geostationary** - a satellite orbit along the equator that results in a constant fixed position over a particular reference point on the earth's surface. (GPS satellites are not geostationary.)

**Global Positioning System (GPS)** - full name NAVSTAR Global Positioning System, a space-based radio positioning system which provides suitably equipped users with accurate position, velocity and time data. When fully operational, GPS will provide this data free of direct user charge worldwide, continuously, and under all weather conditions. The GPS constellation will consist of 24 orbiting satellites, four equally spaced around each of six different orbital planes. The system is being developed by the Department of Defense under U.S. Air Force management.

**HDOP** - Horizontal Dilution of Precision - A numerical value expressing the confidence factor of the horizontal position solution based on current satellite geometry. Makes no constraint assumptions about time, and about height only if the FIX HEIGHT command has been invoked. The lower the HDOP value, the greater the confidence in the solution.

**HTDOP** - Horizontal position and Time Dilution of Precision - A numerical value expressing the confidence factor of the position solution based on current satellite geometry. Assumes height is known if the FIX HEIGHT command has been invoked. If not, it will give the normalized precision of the horizontal and time parameters given that nothing has been constrained. The lower the HTDOP value, the greater the confidence.

**L1 frequency** - the 1575.42 MHz GPS carrier frequency which contains the coarse acquisition (C/A) code, as well as encrypted P-code, and navigation messages used by commercial GPS receivers.

**Mask angle** - the minimum GPS satellite elevation angle permitted by a particular GPS receiver design. Satellites below this angle will not be used in position solution.

**Multipath errors** - GPS positioning errors caused by the interaction of the GPS satellite signal and its reflections.

**Nanosecond** -  $1 \times 10^{-9}$  second.

**Null field** - by NMEA standard, indicates that data is not available for the field. Indicated by two ASCII commas, i.e., “,” (HEX 2C2C), or, for the last data field in a sentence, one comma followed by either the checksum delimiter “\*” (HEX 2A) or the sentence delimiters <CR><LF> (HEX 0D0A). [Note: the ASCII Null character (HEX 00) is not to be used for null fields.]

**Obscuration** - term used to describe periods of time when a GPS receiver's line-of-sight to GPS satellites is blocked by natural or man-made objects.

**P-Code (precise or protected)** - a spread spectrum direct sequence code that is used primarily by military GPS receivers to determine the range to the transmitting GPS satellite. Uses a chipping rate of 10.23 MHz.

**PDOP** - Position Dilution of Precision - A numerical value expressing the confidence factor of the position solution based on current satellite geometry. 3D position (latitude, longitude, height) is unknown. The lower the PDOP value, the greater the confidence factor.

**PRN** - Pseudo-Random Noise number - the identify of the GPS satellites as determined by a GPS receiver. Since all GPS satellites must transmit on the same frequency, they are distinguished by their pseudo-random noise codes.

**Precise Positioning Service (PPS)** - the GPS positioning, velocity, and time service which will be available on a continuous, worldwide basis to users authorized by the U.S. Department of Defense (typically using P-Code).

**Pseudorange** - the calculated range from the GPS receiver to the satellite determined by taking the difference between the measured satellite transmit time and the receiver time of measurement, and multiplying by the speed of light. This measurement generally contains a large receiver clock offset error.

**Residual** - in the context of measurements, the residual is the misclosure between the calculated measurements, using the position solution and actual measurements.

**Satellite elevation** - the angle of the satellite above the horizon.

**Spheroid** - sometimes known as ellipsoid; a perfect mathematical figure which very closely approximates the geoid. Used as a surface of reference for geodetic surveys. The geoid, affected by local gravity disturbances, is irregular.

**Standard Positioning Service (SPS)** - a positioning service made available by the United States Department of Defense which will be available to all GPS civilian users on a continuous, worldwide basis (typically using C/A code)

**SV** - Space Vehicle ID, sometimes used as SVID; also used interchangeably with Pseudo-Random Noise Number (PRN).

**TDOP** - Time Dilution of Precision - A numerical value expressing the confidence factor of the position solution based on current satellite geometry. The lower the TDOP value, the greater the confidence factor.

**Three-dimensional coverage (hours)** - the number of hours-per-day when four or more satellites are available with acceptable positioning geometry. Four visible satellites are required to determine location and altitude.

**Three-dimensional (3D) navigation** - navigation mode in which altitude and horizontal position are determined from satellite range measurements.

**Time-To-First-Fix (TTFF)** - the actual time required by a GPS receiver to achieve a position solution. This specification will vary with the operating state of the receiver, the length of time since the last position fix, the location of the last fix, and the specific receiver design.

**Two-dimensional coverage (hours)** - the number of hours-per-day with three or more satellites visible. Three visible satellites can be used to determine location if the GPS receiver is designed to accept an external altitude input.

**Undulation** - the distance of the geoid above (positive) or below (negative) the mathematical reference ellipsoid (spheroid). Also known as geoidal separation, geoidal undulation, geoidal height.

**Universal Time Coordinated (UTC)** - this time system uses the second-defined true angular rotation of the Earth measured as if the Earth rotated about its Conventional Terrestrial Pole. However, UTC is adjusted only in increments of one second. The time zone of UTC is that of Greenwich Mean Time (GMT).

**Update rate** - the GPS receiver specification which indicates the solution rate provided by the receiver when operating normally.

**VDOP** - Vertical Dilution of Precision - A numerical value expressing the confidence factor of the position solution based on current satellite geometry. The lower the VDOP value, the greater the confidence factor.

**Variable field** - by NMEA standards, a data field which may or may not contain a decimal point and which may vary in precision following the decimal point depending on the requirements and the accuracy of the measuring device.

**WGS-84** - World Geodetic System 1984 is an ellipsoid designed to fit the shape of the entire Earth as well as possible with a single ellipsoid. It is often used as a reference on a worldwide basis, while other ellipsoids are used locally to provide a better fit to the Earth in a local region. GPS uses the center of the WGS-84 ellipsoid as the center of the GPS ECEF reference frame.

1PPS	One Pulse Per Second
2D	Two Dimensional
3D	Three Dimensional
A/D	Analog-to-Digital
ASCII	American Standard Code for Information Interchange
BIT	Built-In Test
bps	Bits per Second
C/A Code	Coarse/Acquisition Code
CEP	Circular Error Probable
C/N <sub>0</sub>	Carrier to Noise Density Ratio
CPU	Central Processing Unit
CR	Carriage Return
dB	Decibel
dBm	Decibel Relative to 1 milliWatt
DGNSS	Differential Global Navigation Satellite System
DGPS	Differential Global Positioning System
DOP	Dilution Of Precision
ECEF	Earth-Centered-Earth-Fixed
EGNOS	European Geo-Stationary Navigation System
EMC	Electromagnetic Compatibility
ESD	Electrostatic Discharge
FOM	Figure of Merit
GDOP	Geometric Dilution Of Precision
GMT	Greenwich Mean Time
GND	Ground
GPS	Global Positioning System
HDOP	Horizontal Dilution Of Precision
hex	Hexadecimal
HFOM	Horizontal Figure of Merit
HTDOP	Horizontal Position and Time Dilution Of Precision



---

Hz	Hertz
ICD	Interface Control Document
IF	Intermediate Frequency
IM	Intermodulation
I/O	Input/Output
LF	Line Feed
LNA	Low Noise Amplifier
msb	Most significant bit
ms	millisecond
MHz	MegaHertz
NAVSTAR	Navigation System with Timing and Ranging
NMEA	National Marine Electronics Association
ns	nanosecond
NVM	Non Volatile Memory
OCXO	Oven Controlled Crystal Oscillator
OEM	Original Equipment Manufacturer
PC	Personal Computer
PCB	Printed Circuit Board
P Code	Precise Code
PDOP	Position Dilution Of Precision
PPS	Precise Positioning Service or Pulse Per Second
PRN	Pseudo-Random Noise Number
PVT	Position Velocity Time
RAM	Random Access Memory
RF	Radio Frequency
ROM	Read Only Memory
RTC	Real-Time Clock
RTCA	Radio Technical Commission for Aviation Services
RTCM	Radio Technical Commission for Maritime Services
SBAS	Satellite-Based Augmentation System

SNR	Signal-to-Noise Ratio
SPS	Standard Positioning Service
SRAM	Static Random Access Memory
SV	Space Vehicle
TCXO	Temperature Compensated Crystal Oscillator
TDOP	Time Dilution Of Precision
TTFF	Time-To-First-Fix
UTC	Universal Time Coordinated
VDOP	Vertical Dilution of Precision
VFOM	Vertical Figure of Merit
WAAS	Wide Area Augmentation System
WGS	World Geodetic System

# Index

## A

- accuracy, 44
  - multipath, 71–73
  - navigation, 36
  - positioning, 38, 54
- acquisition, 32, 44
- acronyms, 81
- active antenna, 22, 24
- aligned mode, 26
- almanac, 24, 26, 32, 63, 68
- ambiguity, pseudorange, 73
- antenna, 22, 56–57
  - active, 17, 22, 24, 58
  - base station, 21
  - design, 73–74
  - gain, 56
  - passive, 59
  - power, 18, 24, 57
  - site, 39, 73
  - specifications, 56–61
- anti-static, 20
- architecture, system, 17

## B

- base, 21, 31–32, 54, 73
- baud rate, 26, 29
- bearing, 73
- block diagram, 17
- broadcast

- corrections, 36
  - ephemeris, 38
  - overview, 68

- buffer, 29

## C

- C/A code, 67, 73
- cables
  - antenna, 56
  - coaxial, 17, 60
  - interface, 54
  - RF, 24
  - serial, 29
  - warranty, 12
- carrier phase, multipath errors, 73
- cautions, 29

- CD, 55

- clock

- bias, 70
  - data, 68
  - drift, 36
  - external, 36
- coaxial, 17, 20, 56, 60
- communication, 20, 29, 42–44, 52–54
- configuration, 19, 26, 28–29
- connector, 20–27, 47, 49–55
- constellation, 67
- conversion, 69
- copyright, 2
- Customer Service, 9

## D

- data

- link, 22, 70
  - request, 31

- datum, 34

- DC, 17, 49

- dead-reckoning mode, 33

- defaults, 26, 29

- development kit, 45, 53

- device, supercap, 24

- DGPS, 22, 26

- differential

- corrections, 23, 36, 42, 54
  - mode, 33
  - positioning, 70
  - setup, 54

- dilution of precision (DOP), 38

- dimensions, 45

- discretes, 25

- dynamics, 44

## E

- electrostatic discharge (ESD), 10, 20

- elevation, 73–74

- ephemeris, 32, 63

- errors, 38

- overview, 67

- equipment, development kit, 53

- errors, 33

- ephemeris, 38

- in single-point positioning, 70
- multipath, 73

external oscillator, 36

**F**

fault mode, 33  
features, 14, 29  
figure of merit (FOM), 14, 77  
firmware update, 9  
fix, 54  
FlexPak-SSII, 15, 30, 54  
formats, 37  
frequency, 44, 75

**G**

GEO, SBAS, 39  
Geodetic Survey of Canada, 62  
glossary, 76, 78  
GPS  

- antenna, 12
- overview, 67, 69–70
- time, 38

ground plane, 73, 75

**H**

handshaking, 29  
height  

- antenna, 74
- relationships, 68–69

humidity, 45

**I**

I/O, 22, 26, 48  
idle time, 29  
impedance, 49  
initialization, 32, 63  
input, 23–25, 43–45  
installation, 19  
integration, 19  
interface, 19, 22, 24, 47  
ionosphere, 38

**J**

jerk, 44

**K**

kinematic versus static, 71  
kit, development, 45, 53

**L**

latency, 36  
latitude, 67  
L-band, 67  
license, software, 7  
LNA, *see* low noise amplifier  
longitude, 67  
low noise amplifier (LNA), 18, 56

**M**

mask angle, 31  
master control station, 68  
mean sea level, 67  
memory, 24, 26  
merit (FOM), figure of, 14  
mode  

- dead-reckoning, 33
- differential, 33
- fault, 33
- navigation, 63
- operational, 31
- stand-alone nav, 32

modem, 54  
multipath, 21, 71–75

**N**

navigation  

- accuracy, 36
- gps overview, 67
- mode, 32, 63
- standards, 35

NAVSTAR satellites, 67  
NMEA, 25, 37, 62  
non-volatile memory (NVM), 26  
notices, regulatory, 10  
NovAtel Inc., 2, 9, 12

**O**

OCXO, *see* oscillators  
operation, 28, 30–32  
orbit period, 67  
oscillators, 36, 38  
output, 23, 43, 45, 49

**P**

packaging, 17  
parameter, receiver, 31  
parity, 29, 35

- performance, 44
- phase lock, 73
- polarity, 72
- poor reception, 74
- port, 20, 23, 29, 36
- position, 24, 26, 44, 54
- power, 44
  - antenna, 24
  - apply, 63
  - connector, 51
  - up, 30
- preamplifier, 24
- precision, 68–70
- processing, 68–69
  - circuitry, 18
  - post-mission, 71
- propagation, 38, 71–73
- protocol, 26
- pseudorange
  - corrections, 35, 37
  - errors, 70, 73
  - positioning, 38
- publications, 13
- R**
- radio frequency (RF), 18, 23–24, 44, 71–72, 75
- radio modem, 54
- re-acquisition, 44, 63
- receiver, sections, 17
- regulatory notices, 10
- revision, firmware, 1
- RF, *see* radio frequency
- rover, 22, 32, 36, 54, 70
- RTCM, 35–36, 62
- S**
- SAE, 62
- satellite, 63
  - acquisition, 32
  - ID, 36–37
  - multipath, 72, 74
  - orbit arrangement, 67
  - records, number of, 29
  - tracking, 14
  - transmit, 18
- SBAS, 39–40
- scope, 13
- segment
  - control, 67–68
  - space, 67
  - user, 67–68
- self-test, 30, 32–33, 63
- serial
  - cable, 29
  - communication, 44
- setup, 27, 53–54
- SNR, 42
- Society of Automotive Engineering, 62
- software
  - licence, 7
  - StarView, 55
- space vehicle number (SVN), 67
- stand-alone nav mode, 32
- start, warm, 24
- StarView software, 19, 53, 55
- station, base, 21, 31–32
- status, 33
- supercap device, 24
- support, 12
- surveying, 69–70
- SVN, *see* space vehicle number
- system architecture, 17
- T**
- TCXO, *see* oscillators
- technical specifications, 51
- temperature, 45
- time, 24
  - data, 32
  - to-first-fix (TTFF), 26, 44, 63
- tracking, satellite, 14
- triangulation, 72
- trilateration, 72
- troposphere, 38
- troubleshooting, 42–43
- U**
- U.S. National Geodetic Survey, 62
- update firmware, 9
- V**
- valid almanac, 24
- velocity, 67–68
- voltage, 48

**W**

warm start, 24  
warnings, 11, 18  
warranty, 12, 18, 20  
website, 62  
weight, 45

